

Courtesy of: **C3 Surplus LLC**  
**Surplus Industrial Superstore**  
**305-428-2777**  
**<https://www.c3surplus.com>**



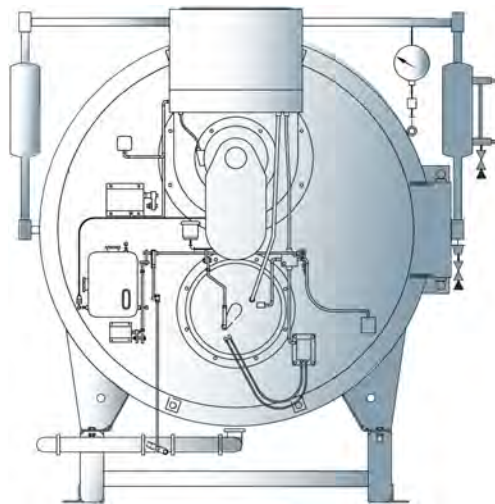
# *Model CB*

## ***Packaged Boiler***

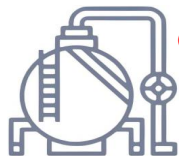
***50 - 100 HP***

***Light Oil, Heavy Oil, Gas, or Combination***

**Operation and Maintenance Manual**



750-96  
06/2010



**⚠ WARNING**

If the information in this manual is not followed exactly, a fire or explosion may result causing property damage, personal injury or loss of life.

— Do not store or use gasoline or other flammable vapors and liquids in the vicinity of this or any other appliance.

— WHAT TO DO IF YOU SMELL GAS

- Do not try to light any appliance.
- Do not touch any electrical switch; do not use any phone in your building.
- Immediately call your gas supplier from a neighbor's phone. Follow the gas supplier's instructions.
- If you cannot reach your gas supplier, call the fire department.

— Installation and service must be performed by a qualified Cleaver-Brooks, service agency or the gas supplier.

**⚠ WARNING**

To minimize the possibility of serious personal injury, fire or damage to the equipment, never violate the following safety rules.

— Always keep the area around the boiler free of combustible materials, gasoline, and other flammable liquids and vapors

— Never cover the boiler, lean anything against it, stand on it, or in any way block the flow of fresh air to the boiler.

**Notice**

Where required by the authority having jurisdiction, the installation must conform to the Standard for Controls and Safety Devices for Automatically Fired Boilers, ANSI/ASME CSD-1.

**⚠ WARNING**

The boiler and its individual shutoff valve must be disconnected from the gas supply piping system during any pressure testing of that system at test pressures in excess of 1/2 psi (3.5 kPa).

**⚠ WARNING**

Improper installation, adjustment, service, or maintenance can cause equipment damage, personal injury, or death. Refer to the Operation and Maintenance manual provided with the boiler. Installation and service must be performed by a qualified Cleaver-Brooks service provider.

**⚠ WARNING**

Be sure the fuel supply which the boiler was designed to operate on is the same type as specified on the boiler name plate.

**⚠ WARNING**

Should overheating occur or the gas supply valve fail to shut off, **do not** turn off or disconnect the electrical supply to the boiler. Instead turn off the gas supply at a location external to the boiler.

**⚠ WARNING**

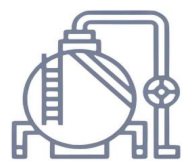
Do not use this boiler if any part has been under water. Immediately call your Cleaver-Brooks service representative to inspect the boiler and to replace any part of the control system and any gas control which has been under water.

**Notice**

This manual must be maintained in legible condition and kept adjacent to the boiler or in a safe place for future reference. Contact your local Cleaver-Brooks representative if additional manuals are required.

**⚠ WARNING**

The installation must conform to the requirements of the authority having jurisdiction or, in the absence of such requirements, to UL 795 Commercial-Industrial Gas Heating Equipment and/or the National Fuel Gas Code, ANSI Z223.1



Courtesy of: **C3 Surplus LLC**  
**Surplus Industrial Superstore**  
**305-428-2777**  
**<https://www.c3surplus.com>**

# ***CLEAVER-BROOKS***

## ***Model CB***

***50-100 HP***

**Light Oil, Heavy Oil, Gas, or Combination  
Operation, Service, and Parts Manual**



© Cleaver-Brooks 2010

Please direct purchase orders for replacement manuals to your local Cleaver-Brooks authorized representative



## **WARNING**

**DO NOT OPERATE, SERVICE, OR REPAIR THIS EQUIPMENT UNLESS YOU FULLY UNDERSTAND ALL APPLICABLE SECTIONS OF THIS MANUAL.**

**DO NOT ALLOW OTHERS TO OPERATE, SERVICE, OR REPAIR THIS EQUIPMENT UNLESS THEY FULLY UNDERSTAND ALL APPLICABLE SECTIONS OF THIS MANUAL.**

**FAILURE TO FOLLOW ALL APPLICABLE WARNINGS AND INSTRUCTIONS MAY RESULT IN SEVERE PERSONAL INJURY OR DEATH.**

### **TO: Owners, Operators and/or Maintenance Personnel**

This operating manual presents information that will help to properly operate and care for the equipment. Study its contents carefully. The unit will provide good service and continued operation if proper operating and maintenance instructions are followed. No attempt should be made to operate the unit until the principles of operation and all of the components are thoroughly understood. Failure to follow all applicable instructions and warnings may result in severe personal injury or death.

It is the responsibility of the owner to train and advise not only his or her personnel, but the contractors' personnel who are servicing, repairing or operating the equipment, in all safety aspects.

Cleaver-Brooks equipment is designed and engineered to give long life and excellent service on the job. The electrical and mechanical devices supplied as part of the unit were chosen because of their known ability to perform; however, proper operating techniques and maintenance procedures must be followed at all times. Although these components afford a high degree of protection and safety, operation of equipment is not to be considered free from all dangers and hazards inherent in handling and firing of fuel.

Any "automatic" features included in the design do not relieve the attendant of any responsibility. Such features merely free him of certain repetitive chores and give him more time to devote to the proper upkeep of equipment.

It is solely the operator's responsibility to properly operate and maintain the equipment. No amount of written instructions can replace intelligent thinking and reasoning and this manual is not intended to relieve the operating personnel of the responsibility for proper operation. On the other hand, a thorough understanding of this manual is required before attempting to operate, maintain, service, or repair this equipment.

Because of state, local, or other applicable codes, there are a variety of electric controls and safety devices which vary considerably from one boiler to another. This manual contains information designed to show how a basic burner operates.

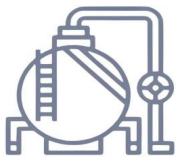
Operating controls will normally function for long periods of time and we have found that some operators become lax in their daily or monthly testing, assuming that normal operation will continue indefinitely. Malfunctions of controls lead to uneconomical operation and damage and, in most cases, these conditions can be traced directly to carelessness and deficiencies in testing and maintenance.

It is recommended that a boiler room log or record be maintained. Recording of daily, weekly, monthly and yearly maintenance activities and recording of any unusual operation will serve as a valuable guide to any necessary investigation. Most instances of major boiler damage are the result of operation with low water. We cannot emphasize too strongly the need for the operator to periodically check his low water controls and to follow good maintenance and testing practices. Cross-connecting piping to low water devices must be internally inspected periodically to guard against any stoppages which could obstruct the free flow of water to the low water devices. Float bowls of these controls must be inspected frequently to check for the presence of foreign substances that would impede float ball movement.

The waterside condition of the pressure vessel is of extreme importance. Waterside surfaces should be inspected frequently to check for the presence of any mud, sludge, scale or corrosion.

It is essential to obtain the services of a qualified water treating company or a water consultant to recommend the proper boiler water treating practices.

The operation of this equipment by the owner and his or her operating personnel must comply with all requirements or regulations of his insurance company and/or other authority having jurisdiction. In the event of any conflict or inconsistency between such requirements and the warnings or instructions contained herein, please contact Cleaver-Brooks before proceeding.



# 750-96 CB Packaged Boilers

## Table of Contents

<b>CHAPTER 1</b>	<i>General Description</i>	<b>1-1</b>
	1.1 — Overview	<b>1-1</b>
	1.2 — The Boiler	<b>1-1</b>
	1.3 — Burner and Control System	<b>1-2</b>
	1.4 — Control and Component Function	<b>1-3</b>
	1.5 — Controls Common to All Boilers	<b>1-3</b>
	1.6 — Steam Controls: All Fuels	<b>1-7</b>
	1.7 — Hot Water Controls: All Fuels	<b>1-8</b>
	1.8 — Controls for Gas Firing	<b>1-8</b>
	1.9 — Controls Common to Oil Fired Boilers (including combination)	<b>1-11</b>
	1.10 — Additional Controls for Heavy Oil (No. 4, 5, and 6)	<b>1-13</b>
	1.11 — Controls for Combination Burners Only	<b>1-14</b>
	1.12 — Combustion Air	<b>1-15</b>
	1.13 — Automatic Ignition	<b>1-15</b>
	1.14 — Atomizing Air	<b>1-16</b>
	1.15 — Oil Fuel Flow: Light Oil	<b>1-16</b>
	1.16 — Oil Fuel Flow: Heavy Oil	<b>1-18</b>
	1.17 — Gas Fuel Flow	<b>1-22</b>
	1.18 — Modulating Firing	<b>1-22</b>

**CHAPTER 2**

*The Pressure Vessel* **2-1**

2.1 — Overview **2-1**

2.2 — Construction **2-1**

2.3 — Water Requirements **2-2**

2.3.1 — *Hot Water Boiler* **2-2**

2.3.1.1 — Air Removal 2-2

2.3.1.2 — Minimum Boiler Water Temperature 2-2

2.3.1.3 — Rapid Replacement of Boiler Water 2-2

2.3.1.4 — Continuous Flow Through the Boiler 2-3

2.3.1.5 — Water Circulation 2-3

2.3.1.6 — Multiple Boiler Installations 2-3

2.3.1.7 — Pressure Drop Through Boiler 2-4

2.3.1.8 — Pump Location 2-4

2.3.1.9 — Pump Operation 2-4

2.3.1.10 — Pressure 2-4

2.3.2 — *Steam Boiler* **2-5**

2.3.2.1 — Feed Pump Operation 2-5

2.3.2.2 — Water Feeder Operation 2-5

2.4 — Water Treatment **2-6**

2.5 — Cleaning **2-7**

2.5.1 — *Hot Water and Steam Piping* **2-7**

2.5.2 — *Pressure Vessel* **2-7**

2.6 — Boil-Out of a New Unit **2-8**

2.7 — Washing Out **2-10**

2.7.1 — *Hot Water Boiler* **2-10**

2.7.2 — *Steam Boiler* **2-10**

2.8 — Blowdown: Steam Boiler **2-10**

2.8.1 — *Manual Blowdown* **2-11**

2.8.2 — *Continuous Blowdown* **2-11**

2.8.3 — *Frequency of Manual Blowdown* **2-11**

2.8.4 — *Manual Blowdown Procedure* **2-12**

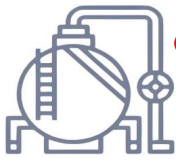
2.9 — Periodic Inspection **2-13**

2.10 — Preparation for Extended Layup **2-14**

**CHAPTER 3**

*Sequence of Operation* **3-1**

3.1 — Overview **3-1**



3.2 — Circuit and Interlock Controls **3-2**

3.3 — Sequence of Operation: Oil or Gas **3-3**

3.3.1 — *Pre-Purge Cycle* **3-3**

3.3.2 — *Ignition Cycle* **3-4**

3.3.3 — *Run Cycle* **3-4**

3.3.4 — *Burner Shutdown Post Purge* **3-5**

3.4 — Flame Loss Sequence **3-5**

3.4.1 — *No Pilot Flame* **3-6**

3.4.2 — *Pilot But No Main Flame* **3-6**

3.4.3 — *Loss of Flame* **3-6**

## **CHAPTER 4**

*Starting and Operating Instructions* **4-1**

4.1 — General Preparation for Startup: All Fuels **4-1**

4.2 — Control Settings: Steam and Hot Water **4-2**

4.3 — Gas Pilot **4-3**

4.4 — Atomizing Air **4-3**

4.5 — Firing Preparations for No. 2 Oil: Series 100-200 **4-4**

4.5.1 — *Oil Flow* **4-4**

4.5.2 — *Oil Pressure* **4-5**

4.5.3 — *Starting* **4-5**

4.6 — Firing Preparations for No. 4 Oil: Series 800-900 **4-6**

4.6.1 — *Oil Flow* **4-6**

4.6.2 — *Oil Pressure* **4-6**

4.6.3 — *Oil Temperature* **4-6**

4.6.4 — *Starting* **4-7**

4.7 — Firing Preparations for No. 5 Oil: Series 300-500 **4-7**

4.7.1 — *Oil Flow* **4-7**

4.7.2 — *Oil Pressure* **4-7**

4.7.3 — *Oil Temperature* **4-8**

4.7.4 — *Starting* **4-8**

4.8 — Firing Preparation for No. 6 Oil: Series 400-600 **4-8**

4.8.1 — *Oil Flow* **4-8**

4.8.2 — *Oil Pressure* **4-9**

4.8.3 — *Oil Temperature* **4-9**

4.8.4 — *Starting* **4-10**

4.9 — Firing Preparations for Gas: Series 200-300-400-700-900 **4-10**

- 4.10 — Startup, Operating, Shutdown: All Fuels **4-12**
  - 4.10.1 — Operating **4-13**
  - 4.10.2 — Shutdown **4-13**

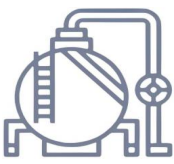
- 4.4 — Control Operational Test and Checks **4-14**

## **CHAPTER 5**

### *Adjustment Procedures* **5-1**

- 5.1 — Overview **5-1**
- 5.2 — Linkage: Modulating Motor and Air Damper **5-1**
- 5.3 — Modulating Motor: Honeywell M954B or M954C **5-4**
- 5.4 — Modulating Motor Switches: Low and High Fire **5-4**
- 5.5 — Burner Operating Controls: General **5-5**
- 5.6 — Gas Pilot Flame Adjustment **5-9**
- 5.7 — Gas Pressure and Flow Information **5-11**
  - 5.7.1 — Pressure **5-11**
  - 5.7.2 — Gas Flow **5-12**
  - 5.7.3 — Pressure Correction **5-12**
- 5.8 — Gas Fuel Combustion Adjustment **5-14**
- 5.9 — Low Gas Pressure Switch **5-17**
- 5.10 — High Gas Pressure Switch **5-17**
- 5.11 — Fuel Oil Pressure and Temperature: General **5-17**
- 5.12 — Fuel Oil Combustion Adjustment **5-18**
- 5.13 — Burner Drawer Adjustment **5-20**
- 5.14 — Oil Drawer Switch **5-21**
- 5.15 — Low Oil Temperature Switch **5-22**
- 5.16 — High Oil Temperature Switch (Optional) **5-22**
- 5.17 — Low Oil Pressure Switch (Optional) **5-22**





5.18 — Electric Oil Heater Thermostat: Steam, Series 400, 600 **5-22**

5.19 — Oil Heater Thermostat: Series 300, 500, 800, 900 **5-23**

5.20 — Steam Oil Heater Thermostat: Steam, No. 6 Oil, Series 400, 600 **5-23**

5.21 — Hot Water Oil Heater Thermostat: Series 400, 600 **5-23**

5.22 — Steam Heater Pressure Regulator: Steam, Series 400, 600 **5-23**

## **CHAPTER 6**

### *Troubleshooting* **6-1**

6.1 — Overview **6-1**

## **CHAPTER 7**

### *Inspection and Maintenance* **7-1**

7.1 — Overview **7-1**

7.1.1 — *Periodic Inspection* **7-1**

7.2 — Fireside Cleaning **7-2**

7.3 — Water Level Controls and Waterside of Pressure Vessel **7-2**

7.4 — Water Gauge Glass **7-4**

7.5 — Electrical Controls **7-4**

7.6 — Program and Flame Safety Control **7-5**

7.6.1 — *Checking Pilot Flame Failure* **7-6**

7.6.2 — *Checking Failure to Light Main Flame* **7-6**

7.6.3 — *Checking Loss of Flame* **7-6**

7.7 — Oil Burner Maintenance **7-7**

7.7.1 — *Oil Strainers* **7-7**

7.7.1.1 — *Light Oil Strainers* **7-7**

7.7.1.2 — *Heavy Oil Strainers* **7-7**

7.7.2 — *Fuel Oil Treatment* **7-7**

7.7.3 — *Cleaning Oil Nozzle* **7-7**

7.7.4 — *Air Purge Nozzle (No. 6 Oil), Back Pressure Orifice Nozzle (No. 2 Oil)* **7-8**

7.7.5 — *Ignition System* **7-8**

7.8 — Gas Burner Maintenance **7-9**

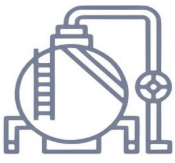
7.9 — Motorized Gas Valve **7-9**

- 7.10 — Solenoid Valves **7-10**
- 7.11 — Cam Spring **7-10**
- 7.12 — Forced Draft Fan **7-10**
- 7.13 — Safety Valves **7-11**
- 7.14 — Fuel Oil Metering Valve, Adjusting and Relief Valves **7-12**
- 7.15 — Air Pump and Lubricating System **7-14**
  - 7.15.1 — Air Pump **7-14**
  - 7.15.2 — Lubricating Oil **7-14**
  - 7.15.3 — Lubricating Oil Strainer and Cooling Coil **7-15**
  - 7.15.4 — Air Cleaner **7-15**
  - 7.15.5 — Air-Oil Tank **7-15**
  - 7.15.6 — Lube Oil Cooling Coil **7-16**
  - 7.15.7 — Flexible Coupling Alignment **7-16**
  - 7.15.8 — Air Pump Replacement **7-17**
    - Dismantling 7-17
    - Reassembly 7-17
- 7.16 — Refractory **7-18**
  - 7.16.1 — Furnace Liner **7-18**
  - 7.16.2 — Liner Installation **7-18**
  - 7.16.3 — Rear Door **7-19**
  - 7.16.4 — Front Inner Door **7-20**
- 7.17 — Opening and Closing Rear Head **7-21**
  - 7.17.1 — Closing and Sealing **7-22**
- 7.18 — Lubrication **7-22**
  - 7.18.1 — Electric Motors **7-22**
  - 7.18.2 — Control Linkage **7-23**
- 7.19 — Oil Heaters: Electric, Steam, Hot Water **7-23**

## **CHAPTER 8**

### ***Ordering Parts and Parts Lists 8-1***

- 8.1 — Ordering Parts **8-1**
  - 8.1.1 — Where to Order Parts **8-2**
  - 8.1.2 — Returning Parts for Repair **8-2**
  - 8.1.3 — Factory Rebuilt Parts **8-2**
- 8.2 — Parts Lists **8-3**
  - 8.2.1 — Rear Head Sealing **8-3**
  - 8.2.2 — Rear Head Sealing - Davit **8-4**
  - 8.2.3 — Fireside Gasket **8-5**

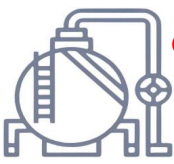


Courtesy of: **C3 Surplus LLC**  
**Surplus Industrial Superstore**  
**305-428-2777**  
**<https://www.c3surplus.com>**



8.2.4	— Front Head Electrical	8-6
8.2.5	— LWCO Water Column Piping, 30 - 125# MDM	8-7
8.2.6	— LWCO Water Column Piping, 15# MDM	8-8
8.2.7	— LWCO Water Column Piping, 150# MDM	8-9
8.2.8	— LWCO Water Column Piping, 15# Level Master	8-10
8.2.9	— LWCO Water Column Piping, 150# Level Master	8-11
8.2.10	— Entrance Box	8-12
8.2.11	— Control Panel	8-13
8.2.12	— Furnace Liner & Bricking	8-15
8.2.13	— Front Head Linkage	8-16
8.2.14	— Temperature Controls	8-17
8.2.15	— Gas Piping	8-18
8.2.16	— L.O. Front Head Oil/Air Piping	8-19
8.2.17	— H.O. Front Head Oil/Air Piping	8-20
8.2.18	— Steam Electric Heater	8-21





## CHAPTER 1 *General Description*

### 1.1 — Overview

The information in this manual applies to Cleaver-Brooks “CB” boiler models ranging from 50 to 100 HP (125 HP for hot water) using the following fuels:

- Series 100 Light Oil (No. 2)
- Series 200 Light Oil (No. 2) or Gas
- Series 300 Heavy Oil (No. 5) or Gas
- Series 400 Heavy Oil (No. 6) or Gas
- Series 500 Heavy Oil (No. 5) only
- Series 600 Heavy Oil (No. 6) only
- Series 700 Gas only
- Series 800 Heavy Oil (No. 4) only
- Series 900 Heavy Oil (No. 4) or Gas

The boiler and related equipment installation, by others, is to be in compliance with the standards of the National Board of Fire Underwriters. Installation should also conform to state and local codes governing such equipment. Prior to installation, the proper authorities having jurisdiction are to be consulted, permits obtained, etc. All boilers in the above series comply, when equipped with optional equipment, to Industrial Risk Insurers (I.R.I.), Factory Mutual (FM), or other insuring underwriters’ requirements.

### 1.2 — The Boiler

The “CB” boiler is a packaged firetube boiler of welded steel construction and consists of a pressure vessel, burner, burner controls, forced draft fan, damper, air pump, refractory, and appropriate boiler trim.

Rated Capacity	50-100 HP (steam) 50-125 HP (hot water)
Operating Pressure	Steam: 15-200 psig, or higher if specified Hot Water: 30-150 psig, or higher if specified

Fuel	Oil or Gas or Combination
Ignition	Automatic
Firing Full Modulation Through Operating Ranges	
Burner (Oil)	(Low Pressure) Air Atomizing
Burner (Gas)	Non-Premix Orificed Type
Air Damper	Rotary Type (Electrically Modulated)
Steam Trim	ASME Code
Water Trim	ASME Code

The horsepower rating of the boiler is indicated by the numbers following the fuel series. Thus, CB700-60 indicates a gas-fired 60 HP boiler.

### 1.3 — Burner and Control System

The oil burner is of the low pressure, air atomizing (nozzle) type. The gas burner is of the non-premix orifice type. The burners are ignited by a spark-ignited gas pilot. The pilot is of the interrupted type and is extinguished after the main flame is established.

**NOTE:** A Series 100 boiler is usually equipped with a light oil pilot although a gas pilot is frequently used.

The burners equipped to burn oil and gas include equipment for each distinct fuel. Since the burner uses only one type of fuel at a time, a gas/oil selector switch is incorporated in a combination burner.

It is important that the burner model and serial number, shown on the nameplate, be included in any correspondence or parts ordered.

Regardless of which fuel is used, the burner operates with full modulation (within its rated operating range) through potentiometer-type positioning controls, and the burner returns to minimum firing position for ignition. High pressure boilers (above 15 psi) can be wired for both low pressure and high pressure modulation as optional equipment. This enables the boiler to operate at lower pressure during off-load hours, but at a somewhat reduced steam output dependent upon lower steam pressure and steam nozzle sizing.

The flame safeguard and program relay includes an infrared sensitive flame detector to supervise both oil and gas flames and to shut the burner down in the event of loss of flame signal. The programming portion of the control provides a pre-purging period, proving of the pilot and main flame, and a period of continued blower operation to purge boiler of all unburned fuel vapor. Other safety controls shut down the burner under low water conditions, excess steam pressure, or water temperature.

Safety interlock controls include combustion and atomizing air proving switches and, depending upon the fuel and insurance carrier requirements, controls that prove the presence of adequate fuel pressure plus temperature proving controls when heated fuel oil is used.

The sequence of burner operation from startup through shutdown is governed by the program relay in conjunction with the operating, limit and interlock devices which are wired into the circuitry to provide safe operation and protect against incorrect operating techniques.

All "CB" boilers have the burner assembly attached to the front head. The entire head may be swung open for inspection and maintenance.

Combustion air is provided by a centrifugal blower located in the front head. Combustion air delivery to the burner is under the control of the damper motor. This same motor regulates the flow of gas fuel through a linkage system connected to the gas butterfly valve and the flow of oil through a cam operated metering valve. Fuel input and air are thus properly proportioned for most efficient combustion.

Filtered primary air for atomizing fuel oil is furnished independently of combustion air by an air pump.

The burner control circuit operates on 115 volt, single phase 60 hertz (or 50 hertz when equipped) alternating current. The forced draft fan motor is generally operated on 3 phase service at the available main power supply voltage.

Indicator lights signaling load demand, fuel valve, low water, and flame failure conditions are standard equipment.

In addition to the standard basic controls supplied, other devices may be required to meet specific requirements of an insurance carrier or local code. Refer to the wiring diagram furnished with the burner to determine the specific controls in the burner and limit control circuits. The function of individual components is outlined in this chapter and the electrical sequence is covered in Chapter 3.

---

## 1.4 — Control and Component Function

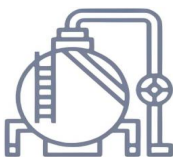
The term "control" covers the more important valves and components, including but not limited to electrical controls or those monitored by the program relay. The operator must become familiar with the individual functioning of all controls whether or not outlined before he can understand the boiler's operation, and procedures outlined in the manual.

The actual controls furnished with any given boiler will depend upon the type of fuel for which it is equipped and whether it is a hot water or steam boiler.

---

## 1.5 — Controls Common to All Boilers

Boilers having optionally ordered features may have control components not listed here.



**Courtesy of: C3 Surplus LLC**  
**Surplus Industrial Superstore**  
**305-428-2777**  
**<https://www.c3surplus.com>**

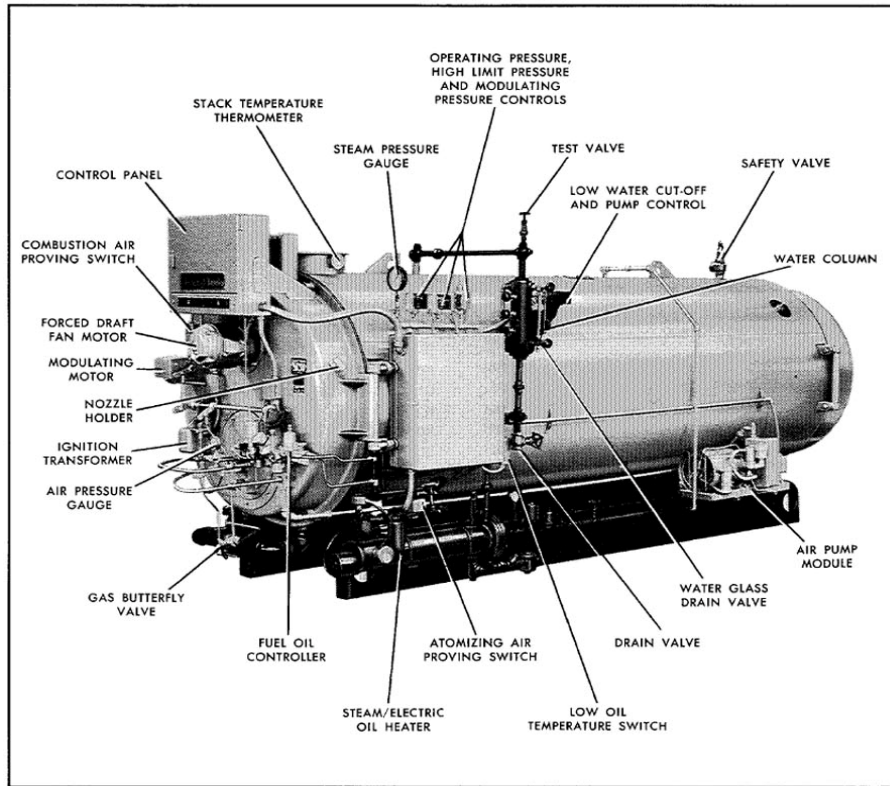


FIGURE 1-1. Typical Steam Boiler - Light Oil Fired

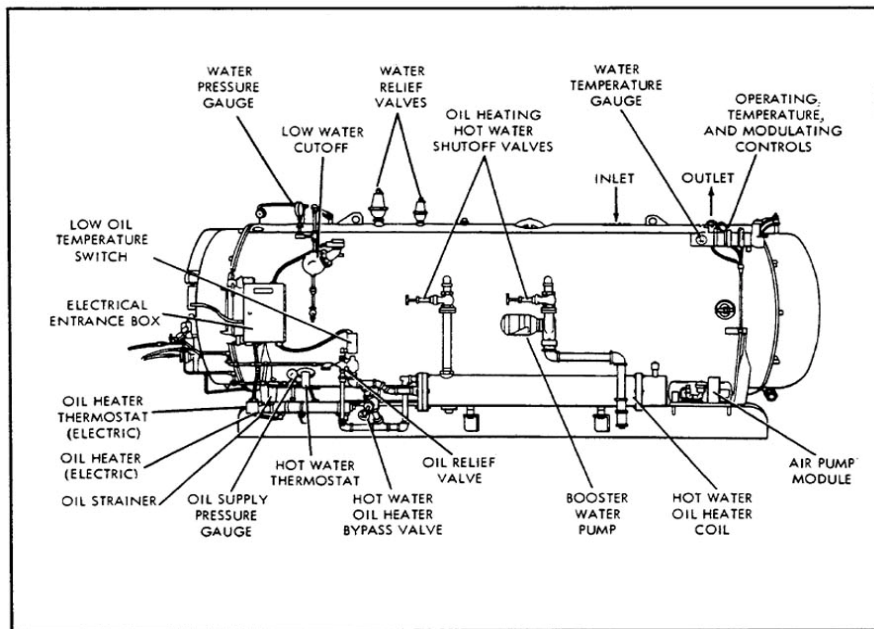
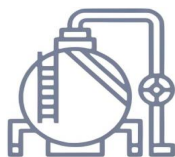


FIGURE 1-2. Typical Hot Water Boiler



<b>Control</b>	<b>Description</b>
1. Forced Draft Fan Motor	Drives forced draft fan directly to provide combustion air. Also referred to as a blower motor.
2. Forced Draft Fan Motor Starter	Energizes forced draft fan (blower) motor.
3. Forced Draft Fan	Furnishes all air, under pressure for combustion of pilot fuel and main fuel, and for purging.
4. Ignition Transformer	Provides high voltage spark for ignition of gas pilot or light oil pilot.
5. Modulating Motor	Operates the rotary air damper and fuel valves through a cam and linkage system to provide proper air-fuel ratios under all boiler load conditions.
6. Low Fire Switch	An internal auxiliary switch, cam actuated by the motor shaft, which must be closed to indicate that the air damper and fuel metering valve are in the low fire position before an ignition cycle can occur.
7. Burner Switch	A manually operated start-stop switch for directly starting and stopping operation of the burner.
8. Manual-Automatic Switch	When set at “automatic,” subsequent operation is at the command of the modulating control, which governs the position of the modulating motor in accordance with load demand.  When set at “manual,” the modulating motor, through the manual flame control, can be positioned at a desired burner firing rate. The primary purpose of the manual position is for testing and setting the air-fuel ratio through the entire firing range.
9. Manual Flame Control	A manually operated potentiometer that permits the positioning of the modulating motor to a desired burner firing rate when the manual-automatic switch is set on manual. It is used primarily for initial or subsequent setting of fuel input throughout the firing range. It has no control over the firing rate when the manual-automatic switch is set on “automatic.”
10. Modulating Motor Transformer	Reduces control circuit voltage (115V AC) to required voltage (24V AC) for operation of the modulating motor.
11. Indicator Lights	Provide visual information on operation of the boiler as follows: * Flame Failure * Load Demand *Fuel Valve (valve open) *Low Water
12. Program Relay and Flame Safeguard Control	Automatically programs each starting, operating, and shutdown period in conjunction with operating limit and interlock devices. This includes, in a timed and proper ignition system, fuel valve(s) and the damper motor. The sequence includes air purge periods prior to ignition and upon burner shutdown.  The flame detector portion of this control monitors both oil and gas flames and provides protection in the event of loss of a flame signal.  The control recycles automatically during normal operation, or following a power interruption. It must be manually reset following a safety shutdown caused by a loss of flame. Incorporated is an internal checking circuit, effective on every start, that will prevent burner operation in the event anything causes the flame relay to hold in during this period.

Control	Description
13. Flame Detector	Monitors gas or oil pilot and energizes the programmer's flame relay in response to a flame signal. It continues to monitor main flame (oil or gas) after expiration of pilot providing period. A standard equipped boiler has a lead sulfide (infrared sensitive) detector.
14. Combustion Air Proving Switch	A pressure sensitive switch actuated by air pressure from the forced draft fan. Its contacts close to prove presence of combustion air. The fuel valves cannot be energized unless this switch is satisfied.
15. Alarm	Sounds to notify the operator of a condition requiring attention. The alarm is available as optional equipment.
16. Stack Thermometer	Indicates temperature of vented flue gases.
17. Diffuser	This is a circular plate located at the furnace end of the burner drawer to impart a rotary swirling motion to combustion air immediately prior to its entering the flame, thus providing a thorough and efficient mixture with the fuel.
18. Rotary Air Damper	This damper provides accurate control of combustion air in proportion to fuel input for various load demands. It consists of two concentric cylinders with openings. The outer is stationary. The inner is rotated, under control of the modulating motor, to vary the effective size of the openings where they overlap.



Courtesy of: **C3 Surplus LLC**  
**Surplus Industrial Superstore**  
**305-428-2777**  
<https://www.c3surplus.com>

## 1.6 — Steam Controls: All Fuels

Control	Description
1. Steam Pressure Gauge	Indicates boiler's internal pressure.
2. Operating Limit Pressure Control	Breaks a circuit to stop burner operation on a rise of boiler pressure above a selected setting. It is adjusted to stop or start the burner at a preselected pressure setting.
3. High Limit Pressure Control	Breaks a circuit to stop burner operation on a rise of pressure above a selected setting. It is adjusted to stop the burner at a preselected pressure above the operating limit control setting. This control is normally equipped with a manual reset.
4. Modulating Pressure Control	Senses changing boiler pressures and transmits this information to the modulating motor to change the burner's firing rate when the manual-automatic switch is set to automatic.
5. Low Water Cutoff and Pump Control	<p>This float-operated control responds to the water level in the boiler. It performs two distinct functions:</p> <p>a) Stops firing of the burner if water level lowers below the safe operating point and energizes the low water light in the control panel; also causes low water alarm bell (optional equipment) to ring. Code requirements of some models require a manual reset type of low water cutoff. This type requires manual resetting to start the burner after a low water shutdown.</p> <p>b) Starts and stops the feedwater pump (if used) to maintain water at the proper operating level.</p> <p><b>NOTE:</b> Determine that control is plumb after shipment and installation and throughout operating life.</p>
6. Auxiliary Low Water Cutoff (optional equipment)	<p>This control breaks the circuit to stop burner operation in the event boiler water drops below the master low water cutoff point. Manual reset type (optional equipment) requires manual resetting in order to start the burner after a low water condition.</p> <p><b>NOTE:</b> Determine that control is plumb after shipment and installation and throughout operating life.</p>
7. Low Water Pump Control Instruction Plate	Gives instructions and information for operation of low water devices.
8. Water Column	This assembly houses the low water cutoff and pump control and includes the water gauge glass, gauge glass shutoff cocks, and trycocks.
9. Water Column Drain Valve	The water column drain valve is provided so that the water column and its piping can be flushed regularly to assist in keeping cross-connecting piping and float bowl clean and free of sediment. A similar drain valve is furnished with auxiliary low water cutoff (optional equipment) for the same purpose.
10. Water gauge Glass Drain Valve	This valve is provided to flush the gauge glass.
11. Test Valve	This valve allows the boiler to be vented during filling, and facilitates routine boiler inspection.
12. Safety Valve	<p>Safety valves relieve the boiler of pressure higher than the design pressure, if designated. Safety valves and their escape piping are to be installed to conform to the ASME Code requirements.</p> <p><b>NOTE:</b> Only the safety valves manufacturer's representative should adjust or repair the boiler safety valves.</p>

## 1.7 — Hot Water Controls: All Fuels

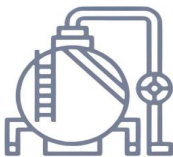
Control	Description
1. Water Temperature Gauge	Indicates the boiler's internal water temperature.
2. Water Pressure Gauge	Indicates the boiler's internal water pressure.
3. Operating Limit Temperature Control	Breaks a circuit to stop burner operation on a rise of boiler temperature above a selected setting. It is adjusted to stop or start the burner at a preselected operating temperature.
4. High Limit Temperature Control	Breaks a circuit to stop burner operation on a rise of temperature above a selected setting. It is adjusted to stop the burner at a preselected temperature above the operating control setting. The high limit temperature control normally is equipped with a manual reset.
5. Modulating Temperature Control	Senses changing boiler temperature and transmits this information to the modulating motor to change the burner's firing rate when the manual-automatic switch is set on automatic.
6. Low Water Cutoff	Breaks the circuit to stop burner operation if water level in the boiler drops below a safe operating point, activating low water light and optional alarm bell if the burner is so equipped.
7. Auxiliary Low Water Cutoff (optional)	Breaks the circuit to stop burner operation if the water level in the boiler drops below the master low water cutoff point.
8. Relief Valve(s)	Relief valve(s) relieve the boiler of pressure higher than the design pressure or a lower pressure, if designated. Relief valves and their discharge piping are to be installed to conform to ASME Code requirements.  <b>NOTE:</b> Only the relief valves manufacturer's representative should adjust or repair the boiler relief valves.

## 1.8 — Controls for Gas Firing

Depending upon the requirements of the insurance carrier or other governing agencies, the gas flow control system, or gas train, may consist of some, or all, of the following items.

Control	Description
1. Gas Pilot Valve	A solenoid valve that opens during the ignition period to admit fuel to the pilot. It closes after main flame is established. The sequence of energizing and de-energizing is controlled by the programming relay. A second gas pilot valve may be required by insurance regulations.
2. Gas Pilot Vent Valve	When a second gas pilot valve is required, a normally open vent valve is installed between them. Its purpose is to vent gas to the atmosphere, should any be present in the pilot line when the pilot valves are closed. The valve closes when the pilot valves are energized.
3. Gas Pilot Shutoff Cock	For manually opening or closing the gas supply to the gas pilot valve.
4. Gas Pilot Adjusting Cock	Provided to regulate the size of the gas pilot flame.

<b>Control</b>	<b>Description</b>
5. Gas Pilot Aspirator	Improves flow of gas to the pilot.
6. Gas Pressure Gauge	Indicates gas pressure to the pilot.
7. Gas Pressure Regulating Valve	Reduces incoming gas pressure to suit the pilot's requirement of between 5" to 10" W.C.
8. Butterfly Gas Valve	The pivoted disc in this valve is actuated by connecting linkage from the gas modulating cam to regulate the rate of gas flow to the burner.
9. Gas Modulating Cam	An assembly, consisting of a quadrant, a series of adjustable allen-head screws, and a contour spring, provided for adjustment of gas input at any point in the modulating range.
10. Main Gas Cock	For manually opening and closing the main fuel gas supply downstream of the main gas line pressure regulator. A second shutoff cock, downstream of the main gas valve(s), may be installed to provide a means of shutting off the gas line whenever a test is made for leakage across the main gas valve.
11. Main Gas Valves	An electrically actuated shutoff valve. when open, it admits main flame gas through the butterfly (modulating) gas valve. The valve may be equipped with a "proof of closure" switch connected into a pre-ignition interlock circuit. A second motorized shutoff gas valve is often used. Item 12 is also used when required.
12. Main Gas Vent Valve	A normally open solenoid valve installed between the two main gas valves to vent gas to the atmosphere should any be present in the main gas line when the gas valves are de-energized. The vent valve closes when the gas valves are energized.
13. Low Gas Pressure Switch	A pressure actuated switch that is closed whenever main gas line pressure is above a pre-selected pressure. Should the pressure drop below this setting, the switch contacts will open a circuit causing the main gas valve(s) to close, or prevent the burner from starting. This switch is usually equipped with a device that must be manually reset after being tripped.
14. High Gas Pressure Switch	A pressure actuated switch that is closed whenever main gas line pressure is below a preselected pressure. Should the pressure rise above the setting, the switch contacts will open a circuit causing the main gas valve(s) to close, or prevent the burner from starting. This switch is usually equipped with a device that must be manually reset after being tripped.
15. Leakage Connection	The body of the gas valve has a plugged opening that is used whenever it is necessary or desirous to conduct a test for possible leakage across the closed valve.



**Courtesy of: C3 Surplus LLC**  
**Surplus Industrial Superstore**  
**305-428-2777**  
**<https://www.c3surplus.com>**

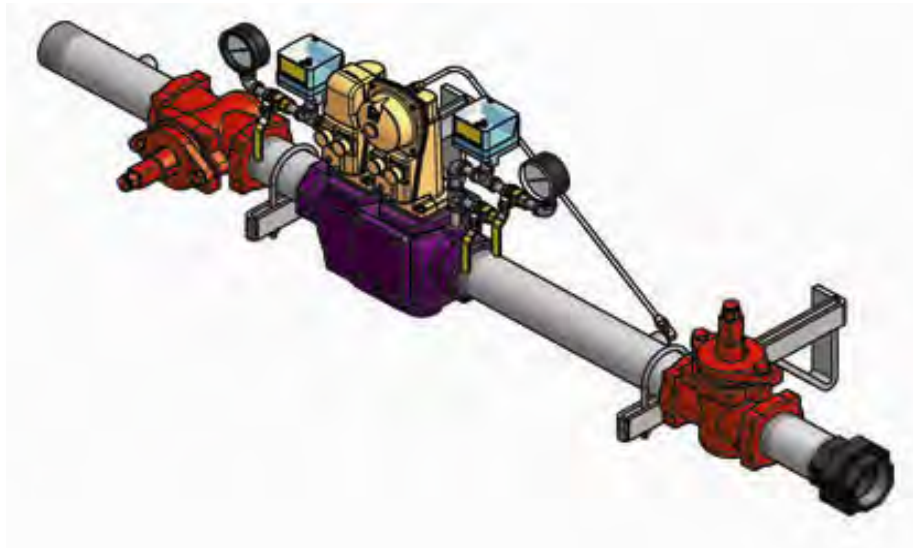


FIGURE 1-3. Gas Train (configurations may vary)

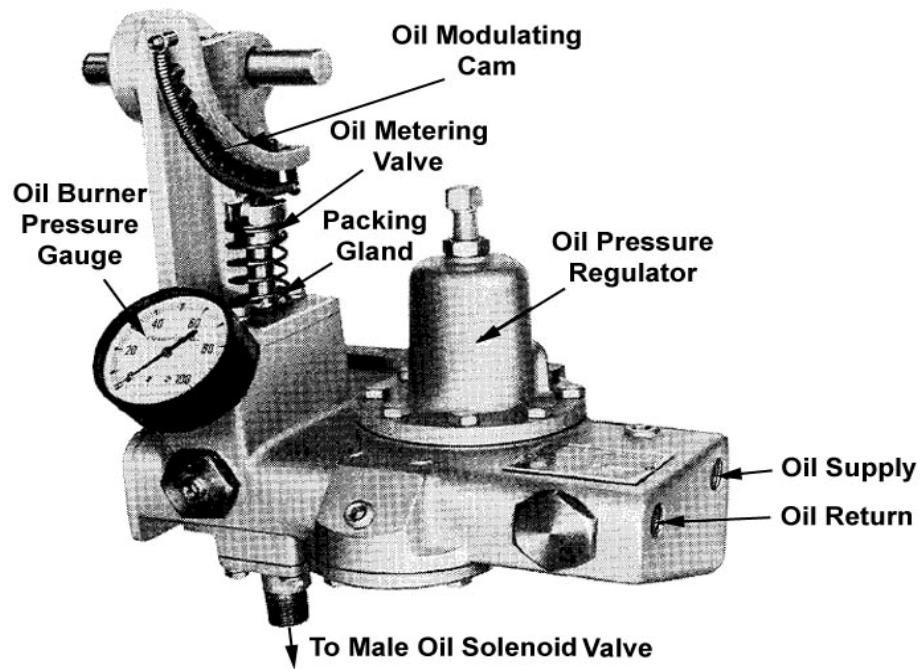


FIGURE 1-4. Oil Control Valve Assembly: For Light Oil

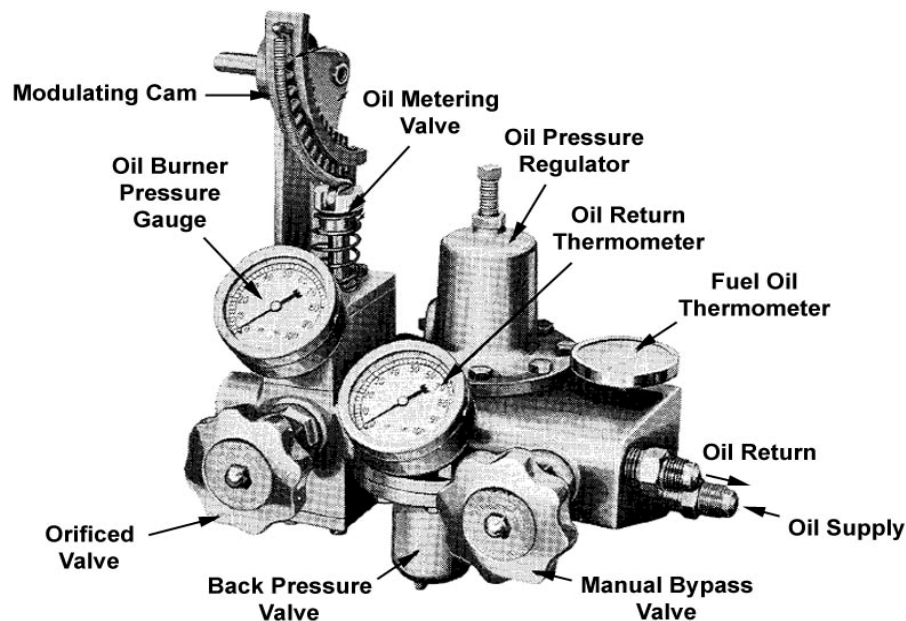


FIGURE 1-5. Oil Control Valve Assembly: For Heavy Oil

## 1.9 — Controls Common to Oil Fired Boilers (including combination)

The following items are applicable to all oil fired or gas and oil fired boilers. Additional controls for No. 4, 5, or 6 oil are listed in Section 1.10.

Control	Description
1. Oil Drawer Switch	Opens the limit circuit if the oil drawer burner gun is not latched in the forward position, which is required for burning oil.
2. Atomizing air Proving Switch	Pressure actuated switch whose contacts are closed when sufficient atomizing air pressure from the air pump is present for oil firing. Oil valve(s) will not open or will not remain open unless switch contacts are closed.
3. Air Pump Module	This assembly provides the compressed air required to atomize the fuel oil for proper combustion. It is started automatically by the programmer's sequence.
4. Air Pump Motor	This motor drives the air pump and an air cooling fan. The motor is started and stopped simultaneously with the forced draft fan motor.
5. Air Pump	Provides air for atomization of fuel oil.
6. Air Filter	An oil bath type strainer to clean the air supply prior to entering the air pump.
7. Check Valve	Prevents lubricating oil and compressed air from surging back through the pump and air filter when the pump stops.
8. Air-Oil Receiver Tank	Holds supply of oil for lubricating the air pump. Separates lube oil from atomizing air before delivery to the nozzle.

Control	Description
9. Atomizing Air Pressure Gauge	Indicates the atomizing air pressure at the burner gun.
10. Lube Oil Level Sight Glass	Indicates the level of lubricating oil in the air-oil receiver tank.
11. Lube Oil Cooling Coil	Cools the lubricating oil before it enters the air pump. A fan driven by the air pump motor circulates cooling air over the coil.
12. Lube Oil Strainer	Filters lubricating oil before it enters the air pump.
13. Lube Oil Fill Pipe and Strainer	Used when adding oil to the air-oil receiver tank.
14. Air Intake Control	An adjustable cock, located on the air intake pipe adjacent to the air filter, used to limit pump output, if necessary.
15. Oil solenoid Valve	Opens when energized through contacts in the programmer and allows fuel oil flow from the oil metering valve to the burner nozzle. A light oil fired burner uses two valves operating simultaneously.
16. Fuel Oil Controller	<p>An assembly combining into a single unit the gauges, regulators, and valves required for regulating the flow of fuel oil. All controllers have the following integral parts. In addition to these, the controller used on an No. 5 or 6 oil fired burner has additional components described in Section 1.10.</p> <p>a) Oil Metering Valve: Valve metering stem moves to increase or decrease the orifice area to regulate the supply of fuel oil to the burner nozzle in accordance with boiler load variances. Stem movement is controlled by the modulating motor through linkage and oil metering cam.</p> <p>b) Oil Modulating Cam: Assembly consisting of a quadrant, a series of adjustable allen-head screws, and a contour spring provided for adjustment of oil input at any point in the modulating range.</p> <p>c) Oil Burner Pressure Gauge: Indicate pressure of the fuel oil at the metering valve.</p> <p>d) Oil Pressure Regulator: For adjustment of the pressure of oil at the metering valve.</p>
17. Fuel Oil Pump	Transfers fuel oil from storage tank and delivers it under pressure to the burner system.
18. Oil Relief Valve	Bypasses excess fuel oil and maintains pressure indicated on oil supply pressure gauge.
19. Fuel Oil Strainer	Provided to prevent foreign matter from entering the burner system.
20. Gas Pilot	See section 1.8 for component descriptions.
21. Light Oil Pilot Valve	When a light oil pilot is furnished, a solenoid valve is provided to control flow of fuel to the pilot nozzle. It is energized through the contacts of a programmer when pilot ignition is desired. It is de-energized to shut off pilot fuel flow after main flame is ignited and established.
22. Back Pressure Orifice	A restriction located in the oil return line immediately downstream of the fuel oil controller to create back pressure (100 and 200 series only).



Courtesy of: **C3 Surplus LLC**  
**Surplus Industrial Superstore**  
**305-428-2777**  
<https://www.c3surplus.com>



## 1.10 — Additional Controls for Heavy Oil (No. 4, 5, and 6)

**NOTE:** Items 6 and 7 are applicable only on a hot water boiler. They may not be provided if other means are available to supply heated oil.

Control	Description
1. Oil Heater Switch	Manually provides power to oil heater system.
2. Oil Heater (Electric)	Used for heating sufficient fuel oil for low fire flow during cold starts before steam or hot water is available for heating. The heater must be turned off during extended boiler layup, or at any time the fuel oil transfer pump is stopped.
3. Oil Heater (Steam/Hot Water)	Heats fuel oil through medium of steam or hot water. Electric heater is housed in the steam heater, but is housed separately on a hot water heater. Steam oil heaters on 15 psi boilers will operate at boiler pressure. Steam oil heaters furnished on high pressure boilers are also to be operated at less than 15 psi. This is accomplished with a steam pressure regulator valve.
4. Electric Oil Heater Thermostat	Senses fuel oil temperature and energizes or de-energizes the electric oil heater to maintain required temperature.
5. Steam Oil Heater Thermostat	Senses fuel oil temperature and controls the opening and closing of the steam heater valve to maintain the selected temperature.
6. Hot Water Oil Heater Thermostat	This control is used on a hot water boiler to sense fuel oil temperature and control the starting and stopping of the booster water pump to supply hot water to the pre-heating assembly to maintain the selected temperature.
7. Booster Water Pump	Started and stopped by the hot water thermostat to regulate the flow of hot water through the hot water oil heater to maintain temperature of fuel oil.
8. Oil Heater Steam Valve	A normally open solenoid valve opened by the steam oil heater thermostat to allow flow of steam to the steam heater to maintain temperature of fuel oil.
9. Steam Heater Check Valve	Prevents oil contamination of the waterside of pressure vessel should any leakage occur in the oil heater.
10. Steam Heater Pressure Regulator	Adjust to provide reduced (usually less than 15 psi) steam pressure to the heater to properly maintain the required fuel oil temperature. This regulator and the pressure gauge are not furnished on 15 psi units.
11. Steam Trap	Drains condensate and prevents loss of steam from the steam oil heater. Its discharge must be piped to waste.
12. Check Valve (Steam Heater Discharge)	Prevents air entry during shutdown periods when cooling action may create vacuum within the steam heater.
13. Oil Supply Pressure Gauge	Indicates fuel oil pressure in the oil heater and supply pressure to the fuel oil controller's pressure regulator.
14. Low Oil Temperature Switch	Thermostatic switch that prevents burner from starting, or stops burner firing if fuel oil temperature is lower than required for oil burner operation.
15. High Oil Temperature Switch (optional)	Switch contacts open when fuel oil temperature raises above a selected temperature. Switch will interrupt the limit circuit in the event fuel oil temperature rises above the selected point.

Control	Description
16. In addition to the Fuel Oil Controller components mentioned in Section 1.9	<p>a) Fuel Oil Thermometer: Indicates temperature of fuel oil being supplied to the fuel oil controller.</p> <p>b) Back Pressure Valve: For adjustment of the oil pressure on the downstream side of the metering valve. Also regulates rate of return oil flow.</p> <p>c) Oil Return Pressure Gauge: Indicates the oil pressure on return side of fuel oil controller.</p> <p>d) Manual Bypass Valve: Provided as a time saver in establishing oil flow. When open it permits circulation of oil through the supply and return lines. Prior to initial light off, this valve must be closed.</p> <p>e) Orifice Oil Control Valve: Valve may be opened prior to startup to aid in establishing fuel oil flow through the controller. Prior to initial light off, this valve must be closed. Its disc has an orifice to permit a continuous circulation of hot fuel oil through the controller.</p>
17. Air Purge Valve	Solenoid valve opens simultaneously with closing of oil solenoid valve at burner shut-down allowing compressed air to purge oil from the burner nozzle and adjacent piping. This oil is burned by the diminishing flame which continues burning for approximately 4 seconds after oil solenoid valve closes.
18. Air Purge Orifice Nozzle	Limits purging air to proper quantity for expelling unburned oil at normal delivery rate.
19. Air Purge Orifice Nozzle Filter	Filters the purging air of any particles which might plug the air purge orifice nozzle.
20. Air Purge Check Valve	Valve check prevents fuel oil from entering the atomizing air line.
21. Air Purge Relay	When energized, controls operation of air purge valve.

**NOTE:** The fuel oil controller shown in Figure 1-5 is for a No. 5 or 6 oil fired burner. Some of the above items are not required on burners equipped for No. 4 oil. Oil flow, and its control, for each of the grades of oil is outlined in Section 1.16 of this chapter. Nozzle purge is provided only on No. 5 and 6 oil burners.

### 1.11 — Controls for Combination Burners Only

Control	Description
1. Gas-Oil Switch	Burners equipped to burn either oil or gas include equipment for each fuel. The selector switch routes electrical circuitry through those controls and interlocks required for the particular fuel. Chapter 4 details the required mechanical functions of each fuel system.



Courtesy of: **C3 Surplus LLC**  
**Surplus Industrial Superstore**  
**305-428-2777**  
<https://www.c3surplus.com>

## 1.12 — Combustion Air

Air for combustion of fuel (often referred to as “secondary” air) is furnished by the forced draft fan mounted in the boiler head. In operation, air pressure is built up in the entire head and is forced through a diffuser plate for a thorough mixture with the fuel for proper combustion. The supply of secondary air to the burner is governed by automatically throttling the output of the fan by regulating the rotary air damper. This furnishes the proper amount of air for correct ratio of air to fuel for efficient combustion at all firing rates.

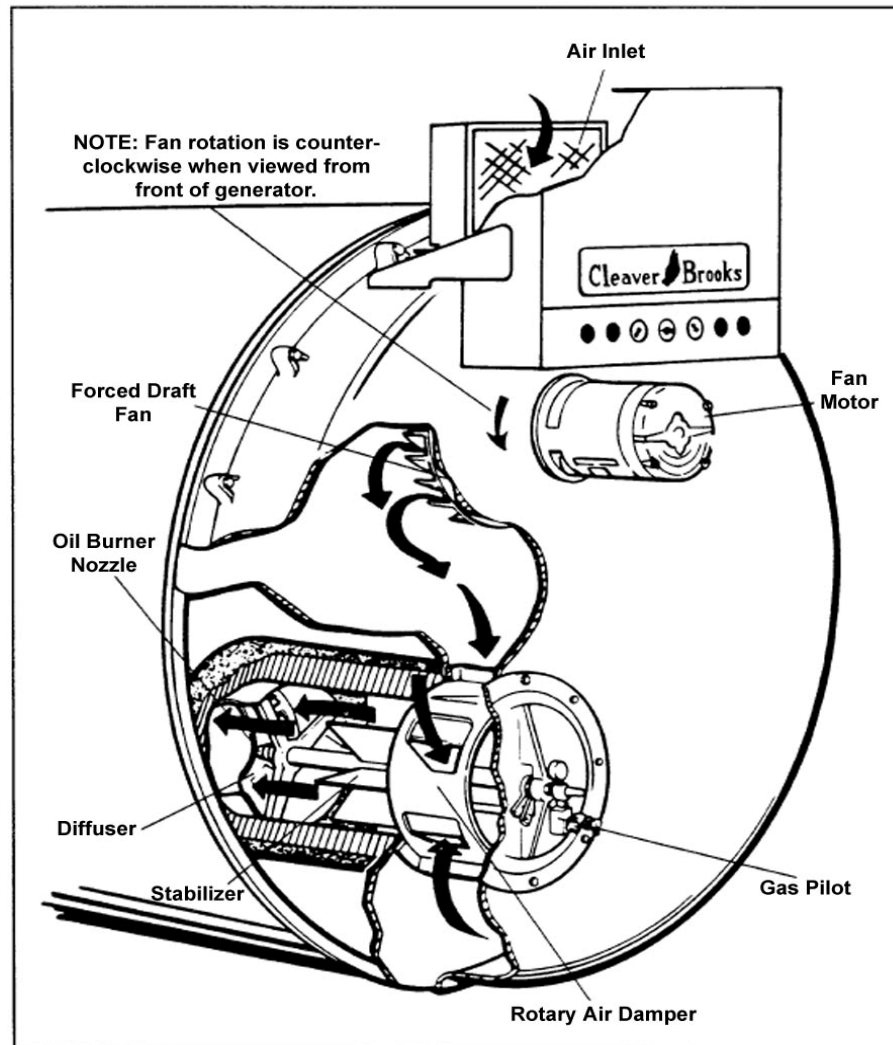


FIGURE 1-6. Secondary Air Flow

## 1.13 — Automatic Ignition

Oil or gas burners are ignited by an interrupted type pilot. The pilot flame is ignited automatically by an electric spark.

A series 100 burner usually is equipped with a pilot fired with light oil fuel. All other burners, as well as a series 100 burner complying with insurance underwriters requirements, are equipped with a gas burning pilot. In the

case of a combination burner, the gas pilot is used to ignite either the main gas flame or the oil flame. Either pilot serves the same function (the term “pilot” is used interchangeably).

At the beginning of the ignition cycle, and governed by the program relay, the pilot solenoid valve and ignition transformer are simultaneously energized.

The ignition transformer supplies high voltage current for the igniting spark. A gas pilot has a single electrode and a spark arcs between the tip of the electrode and the wall of the tube surrounding it. A light oil pilot has two electrodes and the arc is between their tips. The pilot solenoid valve and the transformer are de-energized after main flame is ignited and established.

Fuel for the gas pilot is supplied from the utility’s main or from a tank (bottle) supply. Secondary air flows into and mixes with the pilot gas stream to provide an adequate flame.

Insurance regulations may require two gas pilot solenoids with a normally open vent valve between them. The vent valve closes when the gas pilot valves open, and opens when the gas pilot valves shut to vent gas should any be present in the pilot line during the de-energized period of the gas pilot valves.

Fuel for a light oil pilot is provided from the line that supplies oil under pressure for the main flame. A solenoid actuated valve controls flow of oil to the pilot nozzle. This valve is energized simultaneously with the ignition transformer at the beginning of the ignition cycle and is de-energized after main flame is ignited and established.

---

## 1.14 — Atomizing Air

Air for atomizing the fuel oil (often referred to as “primary air”) is pumped by the air pump into the air-oil receiver tank and delivered under pressure through a manifold block to the oil burner nozzle.

The atomizing air mixes with the fuel oil just prior to the oil leaving the nozzle.

Atomizing air pressure is indicated by the air pressure gauge on the burner gun.

Air pressure from the pump also forces sufficient oil from the tank to the pump bearings to lubricate them and also to provide a seal and lubrication for the pump vanes. As a result the air delivered to the tank contains some lube oil; however, most of it is recovered through baffles and filters in the tank before the air passes to the burner.

---

## 1.15 — Oil Fuel Flow: Light Oil

Fuel oil is delivered into the system by a supply pump which delivers part of its discharge to the oil burner. Excess oil is returned to the oil storage tank through the fuel oil relief valve and oil return line. Normally the pump operates only while the burner is in operation, although often a positioning switch is provided so that either continuous or automatic pump operation can be obtained.

The oil flows through a fuel oil strainer provided to prevent any foreign material from flowing through the control valves and nozzle. The fuel oil controller contains in a single unit, a metering valve, a regulator, and a gauge required to regulate the pressure and flow of oil to the burner. The adjustable regulator controls the pressure. To

assist in this regulating, back pressure is created by an orifice nozzle located in the oil return line immediately downstream of the fuel oil controller.

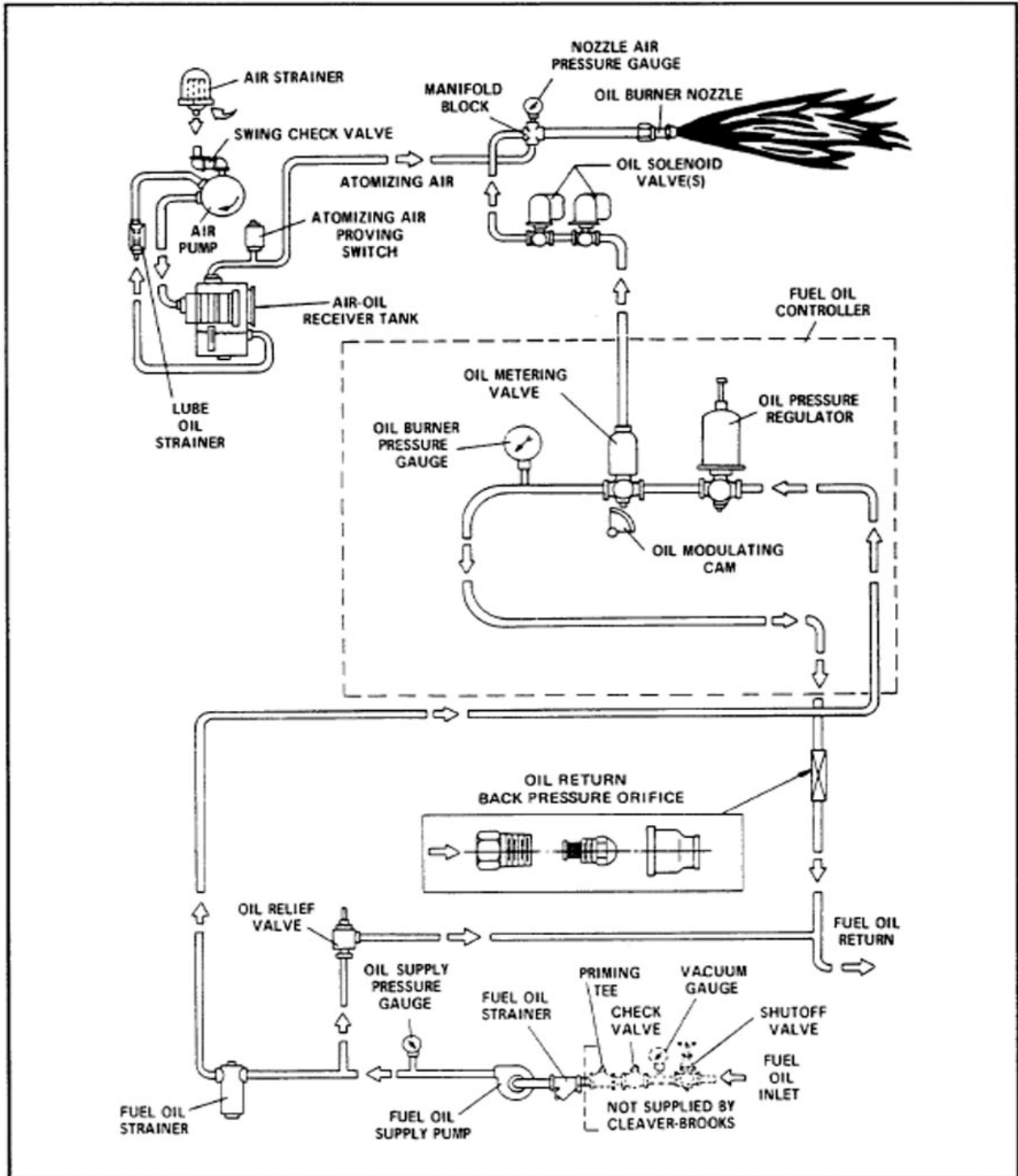


FIGURE 1-7. Light Oil Flow Diagram

The programming relay energizes or de-energizes the solenoid oil valves to permit or cut off oil flow to the burner. Two valves, operating simultaneously, are used. These valves are closed when de-energized. They cannot be opened (energized) unless the combustion air proving switch and the atomizing air proving switch are closed. These are satisfied, respectively, by sufficient combustion air pressure from the forced draft fan and pressurized air from the air pump.

The oil flow to the burner is controlled by the movement of the metering stem in the oil metering valve which varies the flow to meet load demands. The metering valve and the air damper are controlled simultaneously at all times by the modulating motor to proportion combustion air and fuel for changes in load demand.

---

## 1.16 — Oil Fuel Flow: Heavy Oil

Fuel oil is delivered into the system by the fuel oil supply pump which delivers part of its discharge to the oil heater. The remainder of the fuel oil returns to the oil storage tank through a fuel oil relief valve and oil return line.

The combination electric and steam oil preheater is controlled by thermostats. The electric oil heater thermostat energizes the electric heater which is provided to supply heated oil on cold starts. The steam heater thermostat controls the operation of the steam solenoid valve to permit a flow of steam to the heater when steam is available.

A hot water boiler is equipped to heat the oil with hot water from the boiler unless other preheating equipment is used. The electric heater, which is housed separately, is sized to provide heated oil on a cold start. The hot water thermostat controls the operation of a pump that supplies hot water to the oil heater when hot water is available.

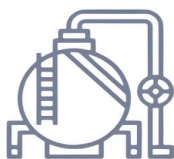
The heated oil flows through a fuel oil strainer to prevent any foreign matter from entering the control valves and nozzle.

The fuel oil controller contains in a single unit the necessary valves, regulators, and gauges to regulate the pressure and flow of oil to the burner.

The program relay energizes or de-energizes the solenoid oil valve to permit or cut off oil flow to the burner. The oil solenoid is closed when de-energized. It cannot be opened (energized) unless the combustion air proving switch, the atomizing air proving switch, and the low oil temperature and any pressure switches are closed. These are satisfied respectively, by sufficient combustion air pressure from the forced draft fan, pressurized air from the air pump, and sufficient oil temperature.

The oil flow to the burner is controlled by the movement of the metering stem of the oil metering valve which varies the flow to meet load demands. The metering valve and the air damper are controlled simultaneously at all times by the modulating motor to proportion combustion air and fuel for changes in load demand.

Oil is purged from the burner gun upon each burner shutdown. The air purge solenoid valve opens as the fuel valve closes and diverts atomizing air through the oil line. This assures a clean nozzle and line for the subsequent restart. (Purging is not provided on No. 4 oil.)



**Courtesy of: C3 Surplus LLC**  
**Surplus Industrial Superstore**  
**305-428-2777**  
**<https://www.c3surplus.com>**

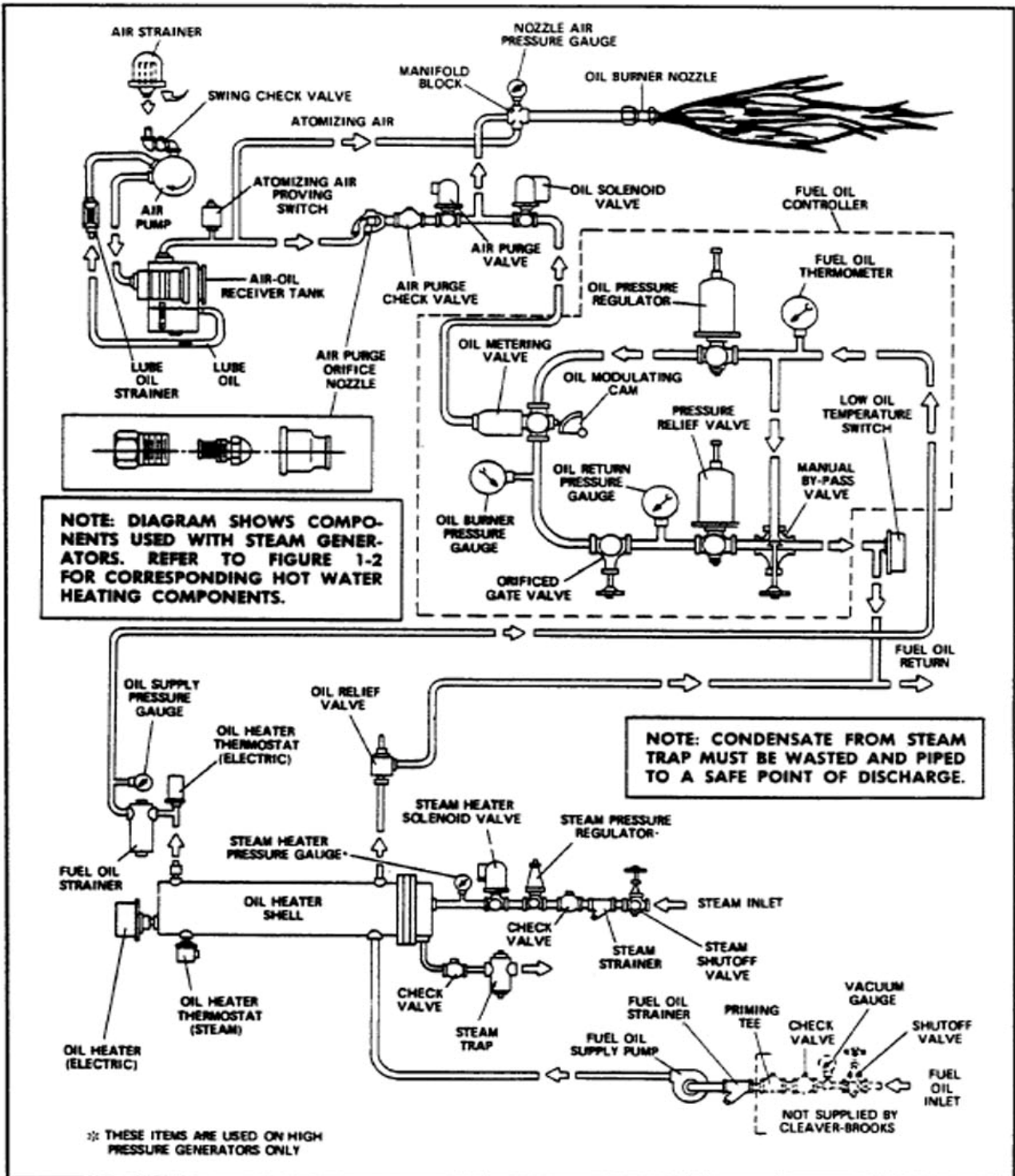


FIGURE 1-8. Heavy Oil Flow Diagram (Steam-Electric Heater)

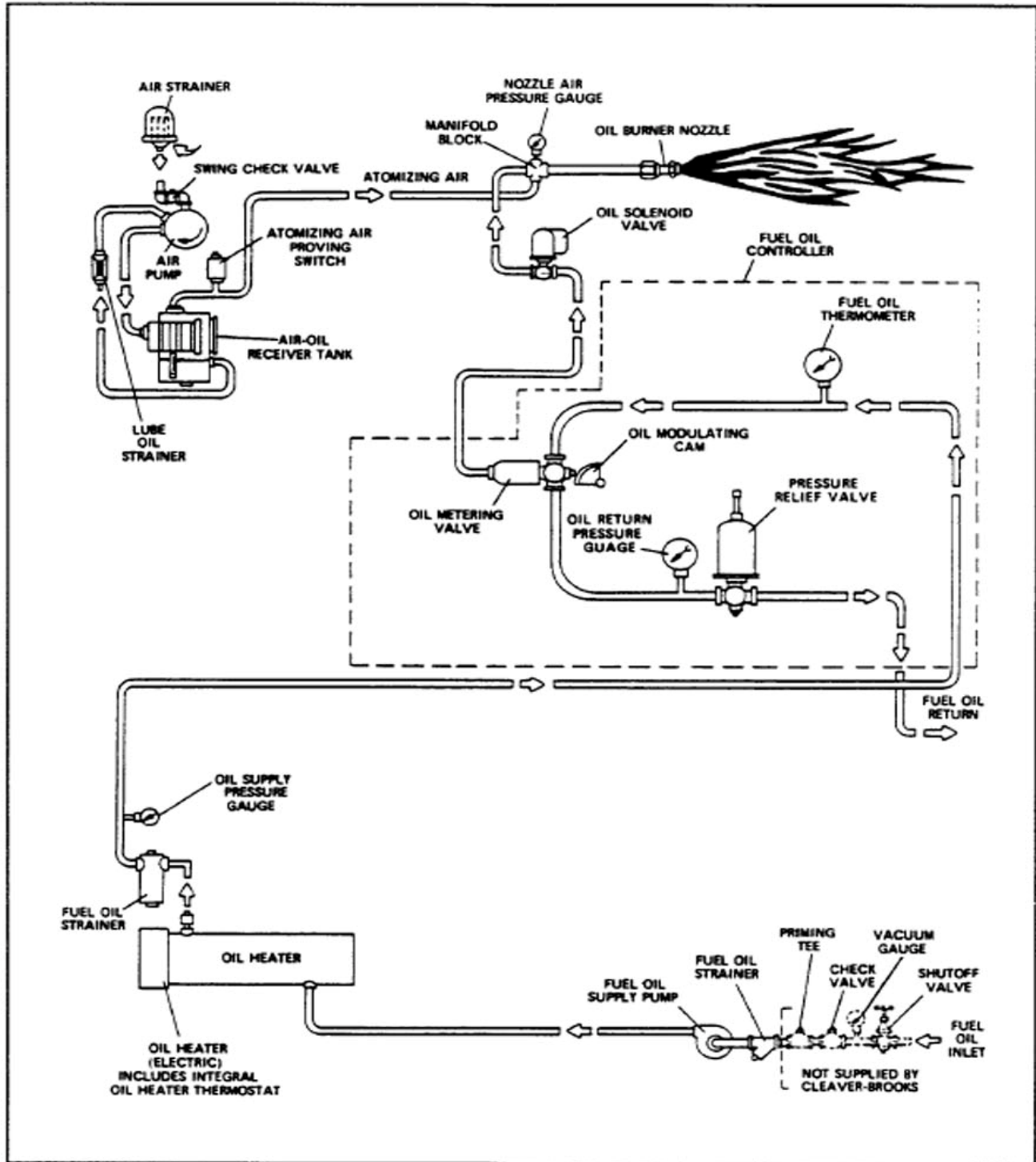
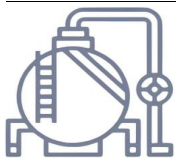


FIGURE 1-9. No. 4 Heavy Oil Flow Diagram



Courtesy of: C3 Surplus LLC  
 Surplus Industrial Superstore  
 305-428-2777  
<https://www.c3surplus.com>



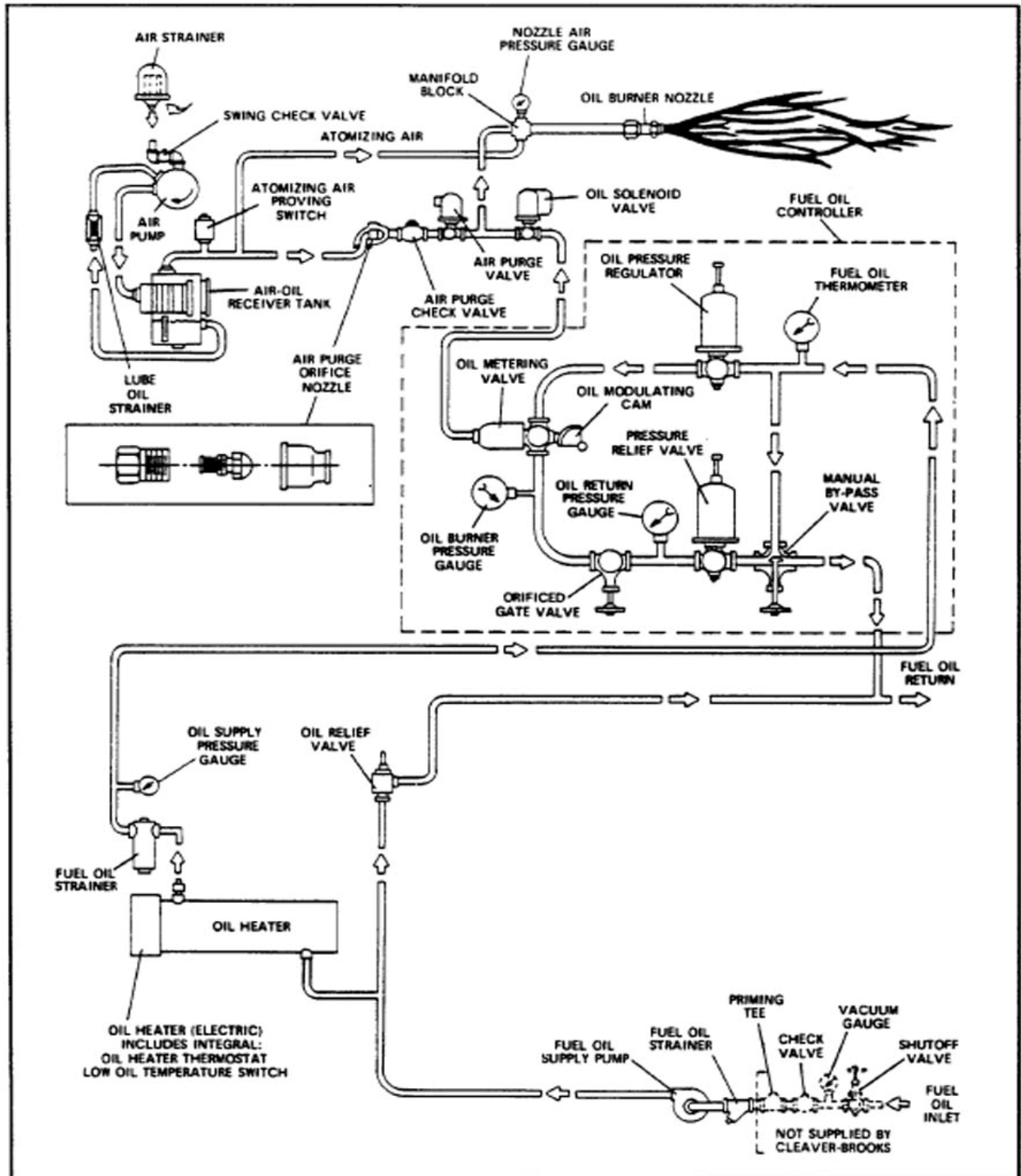


FIGURE 1-10. No. 5 Heavy Oil Flow Diagram

---

## 1.17 — Gas Fuel Flow

Metered gas from the utility flows through the pressure regulator at a reduced pressure suitable to the burner's requirements, through the main gas shutoff cock, main gas valve(s), and modulating butterfly gas valve to the non-premix orifice type burner.

The main gas valve is of the normally closed type and is opened (energized) in proper sequence by the programming relay.

The butterfly gas valve modulates the flow of gas from low through high fire settings. The position of the butterfly valve disc is governed by the gas modulating cam. The butterfly gas valve and the air control damper are controlled simultaneously by the modulating motor to proportion combustion air and fuel for changes to load demand.

The gas flow rate required for rated burner input depends upon the heating value (BTU/cubic foot) of the gas supplied. The gas pressure regulator adjusts the gas pressure (flow rate) to the entrance of the gas train. The regulator is not always supplied with the burner, but may be provided by others.

The main gas valves cannot be energized (opened) unless the combustion air proving switch is closed to indicate a sufficient supply of combustion air. The low gas pressure and high gas pressure switches must be closed to prove sufficient, but not excessive, gas fuel pressure.

When two main gas valves are used, a normally open vent valve is installed between them. This valve is shut when the main gas valves are opened. When they are closed the vent valve is open to vent gas should any be present.

---

## 1.18 — Modulating Firing

The modulating motor, through a linkage arrangement, controls the air damper and the butterfly gas valve or the oil metering valve to maintain a constant air-fuel ratio throughout the firing range.

During burner operation, the motor is controlled by a modulating pressure control on a steam boiler, or by a modulating temperature control on a hot water boiler. A manually operated potentiometer is provided to permit the positioning of the motor at a desired burner firing rate. This is used primarily for initial or subsequent checking and setting of fuel input. Normal operation should be with the manual-automatic switch in the "automatic" position and under the control of the modulating control.

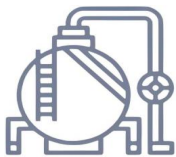
The modulating motor (commonly called a damper motor) is reversible. It has an internal limit switch that restricts shaft rotation to 90°. During normal operation the motor will move in either direction or stop at any position within this range.

The motor's potentiometer is electrically connected to a matching potentiometer in the modulating control. Changing steam pressure or water temperature alters the electrical resistance of the modulating controller's potentiometer. This change in resistance compels an integral balancing relay to start, stop, or reverse the motor rotation. Rotation in either direction continues until the resistance ratio of the two potentiometers is equal.

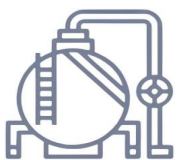
When this occurs, the motor stops in a position that allows the proper fuel and combustion air flow to meet operating demands.

A feature designed into the circuitry is that the modulating motor must be in the low fire position during ignition and remain there until the main flame is established. A low fire switch, integral to the motor, is actuated by the rotation of the motor. The switch must be closed to establish that the damper and fuel metering valves are in low fire position before the programmer commences into the ignition period. During this time, neither the manual flame control nor the modulating control have any control over the damper motor, regardless of their settings.

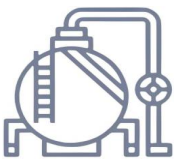
An optionally equipped boiler has a second integral switch used to establish that the motor has driven the damper to an open position during the pre-purge period. This switch closes, as high fire position is approached, to complete an internal circuit in the programmer and allow continuation of the programming cycle.



**Courtesy of: C3 Surplus LLC**  
**Surplus Industrial Superstore**  
**305-428-2777**  
**<https://www.c3surplus.com>**



**Courtesy of: C3 Surplus LLC**  
**Surplus Industrial Superstore**  
**305-428-2777**  
**<https://www.c3surplus.com>**



---

## 2.1 — Overview

This chapter is devoted primarily to the waterside care of the pressure vessel.

The type of service that your boiler is required to provide has an important bearing in the amount of waterside care it will require.

The subject of water supply and treatment cannot adequately be covered in this manual. Nevertheless, it is of prime importance.

Feedwater equipment should be checked and ready for use. See that all valves, piping, boiler feed pumps, and receivers are installed in accordance with prevailing codes and practices.

Water requirements for both steam and hot water boilers are essential to boiler life and length of service. Constant attention to this area will pay dividends in the form of longer life, less downtime, and prevention of costly repairs. Care taken in placing the pressure vessel into initial service is vital. The waterside of new boilers and new or remodeled steam or hot water systems may contain oil, grease, or other foreign matter. A method of boiling out the vessel to remove these accumulations is described later in this chapter.

The operator should be familiar with this chapter before attempting to place the unit into operation.

Boilers, as a part of a hot water system, require proper circulation and the system must be operated as intended by its designer to avoid shock or severe, possibly damaging, stresses occurring to the pressure vessel.

---

## 2.2 — Construction

All pressure vessels are constructed in accordance with the ASME Boiler and Pressure Vessel Code. Steam boilers for operation at pressure not exceeding 15 psig, but within the limits of good safety valve practices, are constructed to Section IV, Low Pressure Heating Boilers, of the Code. Hot water boilers for operation with water temperature not exceeding 240° F may be built up to 160 psig design and constructed to Section IV of Low Pressure Heating Boiler Code. For water temperatures between 240° - 250° F, minimum design pressure is 60 psig, but because of static the head may be as high as 160 psig and constructed to Section IV of Low Pressure Heating Boiler Code.

Those steam boilers designed for operation exceeding 15 psig are constructed in accordance with Section I, Power Boilers, of the ASME Code. Hot water boilers for operation over 250° F are likewise built to this Code.

---

## 2.3 — Water Requirements

### 2.3.1 — Hot Water Boiler

#### 2.3.1.1 — Air Removal

The hot water outlet includes a dip tube which extends 2 to 3 inches into the boiler. This dip tube reduces the possibility of any air which may be trapped at the top of the shell from entering into the system.

Any oxygen or air which is released in the boiler will collect or be trapped at the top of the boiler shell.

The air vent tapping on the top center line of the boiler should be piped into the expansion or compression tank. Any air which is trapped at the top of the boiler will find its way out of the boiler through this tapping.

#### 2.3.1.2 — Minimum Boiler Water Temperature

The minimum recommended boiler water temperature is 170° F. When water temperatures lower than 170° F are used, the combustion gases are reduced in temperature to a point where the water vapor condenses. The net result is that corrosion occurs in the boiler and breeching.

This condensation problem is more severe on a unit which operates intermittently and which is greatly oversized for the actual load. This is not a matter which can be controlled by boiler design, since an efficient boiler extracts all the possible heat from the combustion gases. However, this problem can be minimized by maintaining boiler water temperatures above 170° F.

Another reason for maintaining boiler water temperature above 170° F is to provide a sufficient temperature “head” when No. 6 fuel oil is to be heated to the proper atomizing temperature by the boiler water in a safety type oil preheater. (The electric preheater on the boiler must provide additional heat to the oil if boiler water temperature is not maintained above 200° F.)

<p><b>NOTE:</b> If the water temperature going to the system must be lower than 170° F, the boiler water temperature should be a minimum of 170° F (200° F if used to preheat No. 6 oil) and mixing valves should be used.</p>
--

#### 2.3.1.3 — Rapid Replacement of Boiler Water

The system layout and controls should be arranged to prevent the possibility of pumping large quantities of cold water into a hot boiler, thus causing shock or thermal stresses. A formula, or “magic number,” cannot be given, but it should be kept in mind that 200° F or 240° F water in a boiler cannot be completely replaced with 80° F water in a few minutes time without causing thermal stress. This applies to periods of “normal operation,” as well as during initial startup.

This problem can be avoided in some systems by having the circulating pump interlocked with the burner so that the burner cannot operate unless the circulating pump is running.

When individual zone circulating pumps are used, it is recommended that they be kept running — even though the heat users do not require hot water. The relief device or bypass valve will thus allow continuous circulation through the boiler and can help prevent rapid replacement of boiler water with “cold” zone water.

### 2.3.1.4 — Continuous Flow Through the Boiler

The system should be piped and the controls so arranged that there will be water circulation through the boiler under all operating conditions. The operation of three-way valves and system controls should be checked to make sure that the boiler will not be bypassed. Constant circulation through the boiler eliminates the possibility of stratification within the unit and results in more even water temperatures to the system.

A rule of thumb of 1/2 to 1 G.P.M. per boiler horsepower can be used to determine the minimum continuous flow rate through the boiler under all operating conditions.

Before initial firing or refiring after the boiler has been drained, the operator should determine that a flow of water exists through the boiler.

### 2.3.1.5 — Water Circulation

Boiler Size (BHP)	Boiler Output (1000) Btu/Hr	System Temperature Drop — Degrees F									
		10	20	30	40	50	60	70	80	90	100
		Maximum Circulating Rate — GPM									
15	500	100	50	33	25	20	17	14	12	11	10
20	670	134	67	45	33	27	22	19	17	15	13
30	1,005	200	100	67	50	40	33	29	25	22	20
40	1,340	268	134	89	67	54	45	38	33	30	27
50	1,675	335	168	112	84	67	56	48	42	37	33
60	2,010	402	201	134	101	80	67	58	50	45	40
70	2,345	470	235	157	118	94	78	67	59	52	47
80	2,680	536	268	179	134	107	90	77	67	60	54
100	3,350	670	335	223	168	134	112	96	84	75	67
125	4,185	836	418	279	209	168	140	120	105	93	84
150	5,025	1,005	503	335	251	201	168	144	126	112	100
200	6,695	1,340	670	447	335	268	224	192	168	149	134
250	8,370	1,675	838	558	419	335	280	240	210	186	167
300	10,045	2,010	1,005	670	503	402	335	287	251	223	201
350	11,720	2,350	1,175	784	587	470	392	336	294	261	235
400	13,400	2,680	1,340	895	670	535	447	383	335	298	268
500	16,740	3,350	1,675	1,120	838	670	558	479	419	372	335
600	20,080	4,020	2,010	1,340	1,005	805	670	575	502	448	402
700	23,430	4,690	2,345	1,565	1,175	940	785	670	585	520	470
800	26,780	5,360	2,680	1,785	1,340	1,075	895	765	670	595	535

FIGURE 2-1. Circulation Chart

The chart shows the maximum G.P.M. circulation rate of boiler water in relation to full boiler output and system temperature drop.

### 2.3.1.6 — Multiple Boiler Installations

When multiple boilers of equal or unequal size are used, care must be taken to insure adequate or proportional flow through the boilers. This can best be accomplished by use of balancing cocks and gauges in the supply line from each boiler. If balancing cocks or orifice plates are used, a significant pressure drop (e.g., 3-5 psi) must be taken across the balancing device to accomplish this purpose.

If care is not taken to insure adequate or proportional flow through the boilers, wide variations in firing rates between the boilers can result.

In extreme cases, one boiler may be in the “high fire” position, and the other boiler or boilers may be loafing. The net result would be that the common header water temperature to the system would not be up to the desired point. This is an important consideration in multiple boiler installations.

#### **2.3.1.7 — Pressure Drop Through Boiler**

There will be a pressure drop of less than three feet head (1 psi - 2.31 ft. hd.) through all standard equipped Cleaver-Brooks boilers operating in any system which has more than a 10° F temperature drop.

#### **2.3.1.8 — Pump Location**

It is recommended that the system circulating pumps take suction from the outlet connection on the boiler and that they discharge to the system load. This puts the boiler and the expansion tank on the suction side of the pump. This location is preferred because it decreases air entry into the system and does not impose the system head on the boiler.

It is a common practice to install a standby system circulating pump, and these main circulating pumps are usually located adjacent to the boilers in the boiler room.

#### **2.3.1.9 — Pump Operation**

Pumps are normally started and stopped by manual switches. It is also desirable to interlock the pump with the burner so that the burner cannot operate unless the circulating pump is running.

#### **2.3.1.10 — Pressure**

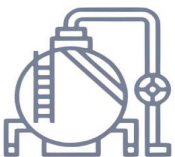
The design of the system and the usage requirements will often dictate the pressure exerted upon the boiler. Some systems are pressurized with air or with an inert gas, such as nitrogen. Caution must be exercised to make sure that the proper relationship of pressure to temperature exists within the boiler so that all of the boiler’s internal surfaces are fully wetted at all times. It is for this reason that the internal boiler pressure be held to the level shown on the chart in Figure 2-2.

When initially firing a newly installed boiler or when cutting an existing boiler into an operating system, the boiler or boilers to be cut into operation must be pressurized equal to the system and/or other boilers prior to cutting in.

It is advisable to have a thermometer installed in the return line to indicate return water temperature. With this determined and with the supply water temperature to the system known, the temperature differential will be established. With knowledge of the pumping rate, the operator can easily detect any excessive load condition and take appropriate corrective action.

Special caution must be taken to guard against any condition, or combination of conditions which might lead to the transfer of cold water to a hot boiler or hot water to a cold boiler. This is particularly true in the case of boilers which are operated for purposes other than supplying hot water for the normal system load (e.g., boilers equipped with coils for domestic hot water).

It cannot be over-emphasized that rapid changes in temperature within the boiler can, and sometimes do, cause damage.



**Courtesy of: C3 Surplus LLC**  
**Surplus Industrial Superstore**  
**305-428-2777**  
**<https://www.c3surplus.com>**



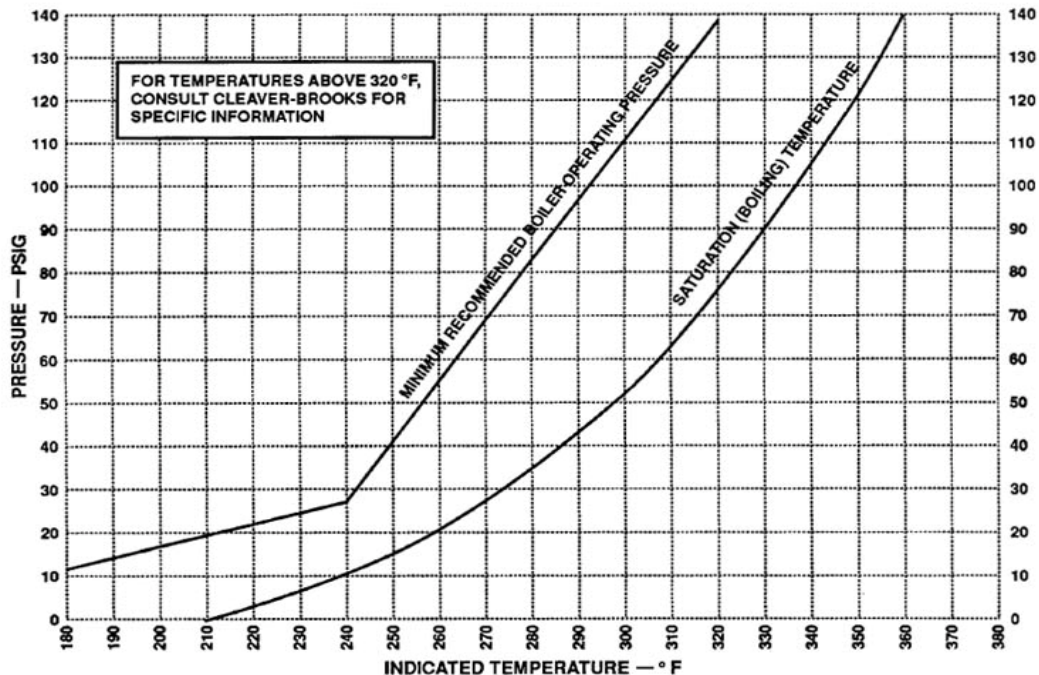


FIGURE 2-2. Pressure-Temperature Chart for Hot Water Boilers

## 2.3.2 — Steam Boiler

### 2.3.2.1 — Feed Pump Operation

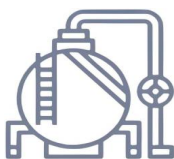
To prevent possible damage to the feed pump mechanism, make certain that all valves in the water feed line are open before turning on the pump motor. After opening valves, momentarily energize the feed pump motor to establish correct pump rotation. With correct rotation, close the boiler feed pump entrance switch. The pump should shut down when the water reaches the proper level.

Feedwater pumps must have adequate capacity to maintain required water level under all operating conditions. Check feedwater pumps periodically and maintain as necessary to prevent unexpected breakdowns.

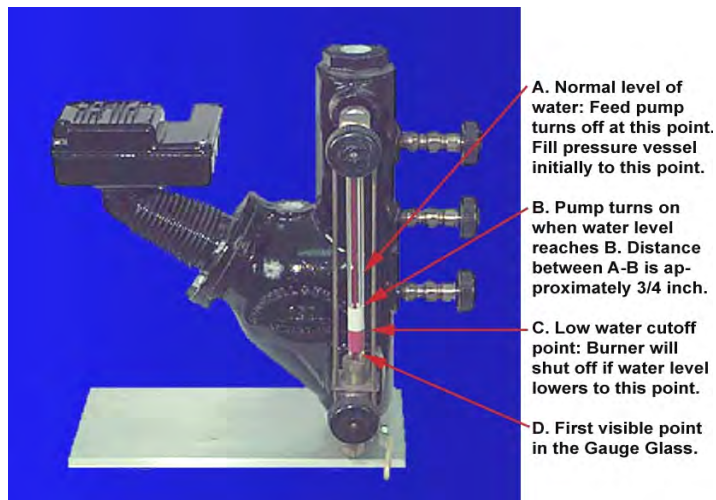
**NOTE:** Prior to operating the pump, carefully check alignment of the flexible coupling if one is used. A properly aligned coupling will last a long time and provide trouble-free mechanical operation.

### 2.3.2.2 — Water Feeder Operation

This type of operation is usually applicable to boilers operating at 15 psi steam or less. It is only necessary to open the water supply line valve and the water feeder discharge valve. The water feeder should close when water reaches the proper level as shown in Figure 2-3.



Courtesy of: **C3 Surplus LLC**  
**Surplus Industrial Superstore**  
 305-428-2777  
<https://www.c3surplus.com>



**FIGURE 2-3. Boiler Water Level Details (Steam Boiler)**

**NOTE:** In the event that water column isolation valves are provided or installed, it must be established that these valves are not only open but that they are sealed or locked in the open position. If these valves are installed, it is illegal to operate the boiler with closed or unsealed open valves.

## 2.4 — Water Treatment

Maximum effectiveness and long trouble-free life of pressure vessels, at the lowest cost consistent with good engineering and operating practice, are functions of properly treated boiler feedwater. The recommendations of a water consultant or a reliable water treating company should be followed rigidly to prevent the presence of unwanted solids and corrosive gases. Objectives of water treatment in general are:

- Prevention of hard scale deposits or soft sludge deposits which impair the rate of heat transfer and can lead to overheated metal and costly downtime and repairs.
- Elimination of corrosive gases in the supply or boiler water.
- Prevention of intercrystalline cracking or caustic embrittlement of boiler metal.
- Prevention of carryover and foaming.

To accomplish these objectives, proper feedwater treatment before and after introduction of the water into the boiler is required. The selection of pre-treatment processes depends upon the water source, its chemical characteristics, amount of makeup water needed, plant operating practices, etc. These treating methods include filtering, softening, de-mineralizing, deaerating, and preheating. After-treatment involves chemical treatment of the boiler water.

Because of the variables involved, no one “boiler compound” can be considered a “cure-all” nor is it advisable to experiment with homemade treating methods. Sound recommendations and their employment should be augmented by a periodic analysis of the feedwater, boiler water, and condensate.

The internal or waterside surfaces of the pressure vessel should be inspected with sufficient frequency to determine the presence of any contamination, accumulations of foreign matter, of corrosion and/or pitting. If these con-

ditions are detected, the water consultant of feedwater treating company should be consulted for advice on corrective action.

It is recommended that a properly sized water meter be installed in the raw water makeup line to accurately determine the amount of raw water admitted to the boiler (steam or hot water) to aid the water treatment program in maintaining proper waterside conditions.

The general feeling exists that a hot water boiler does not require water treatment, but this is a false assumption. The recommendation of a reliable water treating company or a water consultant should be followed rigidly. Even though these units generally operate on closed systems and blowdown is seldom practiced, the need remains to be alert to system water losses and a water meter is recommended for water makeup lines.

---

## 2.5 — Cleaning

### 2.5.1 — Hot Water and Steam Piping

Steam and water piping systems connected to the boiler may contain oil, grease, or foreign matter. These impurities must be removed to prevent damage to pressure vessel heating surfaces. On a steam system, the condensate should be wasted until tests show the elimination of undesirable impurities. During the period that condensate is wasted, attention must be given to the treatment of the raw water used as makeup so that an accumulation of unwanted materials or corrosion does not occur. Follow the advice of your water treatment company.

On a hot water system, chemical cleaning is generally necessary and the entire system should be drained after treatment. Consult water treatment companies for recommendation, cleaning compounds, and application procedures.

### 2.5.2 — Pressure Vessel

The waterside of the pressure vessel must be kept clean from grease, sludge, and foreign material. Such deposits, if present, will not only shorten the life of the pressure vessel and interfere with efficient operation and functioning of control or safety devices, but might quite possibly cause unnecessary and expensive re-work, repairs, and downtime.

The installation and operating conditions which the boiler will be subjected to should be considered and cleaning of the waterside of the pressure vessel should be provided during the course of initial startup.

The pressure vessel and the steam and return lines or hot water piping represent, in effect, a closed system. Although the steam and return (condensate) lines or the hot water piping system may have been previously cleaned, it is possible that:

- Cleaning has been inadequate.
- Partial or total old system is involved.
- Conditions may prevent adequate cleaning of piping.

The pressure vessel waterside should be inspected on a periodic basis. This will reveal true internal conditions and serve as a check against conditions indicated by chemical analysis of the boiler water. Inspection should be made three months after initial starting and at regular 6-, 9-, or 12-month intervals thereafter. The frequency of further periodic inspections will depend upon the internal conditions found.

If any unwanted conditions are observed, your water consultant or water treating company should be contacted for recommendations.

Any sludge, mud, or sediment found will have to be flushed out. The effectiveness of the blowdown practiced on steam boilers will be verified and scheduling or frequency of blowdown may have to be revised. The need for periodic draining or washout will also be indicated.

Any oil or grease present on the heating surfaces should be removed promptly by a boil-out with an alkaline detergent solution.

**NOTE:** Temperature of initial fill of water for hydrostatic tests, boilout, or for normal operation should be as stated in the ASME Boiler Code.

## 2.6 — Boil-Out of a New Unit

The internal surfaces of a newly installed boiler may have oil, grease, or other protective coatings used in manufacturing. Such coatings must be removed since they lower the heat transfer rate and could cause overheating of a tube. Before boiling out procedures may begin, the burner should be ready for firing. The operator must be familiar with the procedure outlined under burner operation.

Your water consultant or water treatment company will be able to recommend a cleaning or boil-out procedure. In the event such service is unavailable or is yet unscheduled, the following information may be of assistance.

There are several chemical suitable for this purpose. Soda ash (sodium carbonate) and caustic soda (sodium hydroxide) at the rate of 3 to 5 pounds each per 1,000 pounds of water, along with a small amount of laundry detergent added as a wetting agent is one combination often used.

Cleaver-Brooks markets a prepared alkaline-phosphate blend under the trade name of “Poly-Clean.” This is available in various container sizes from your Cleaver-Brooks Service and Parts Representative. Follow the provided instructions for its use.

The suggested general procedure for cleaning a boiler is:

1. Refer to the chart below to determine water capacity and have sufficient cleaning material on hand.

Boiler Model and Size	Water - Gallons		Water - Weight	
	Normal	Flooded	Normal	Flooded
CB50	375	440	3125	3665
CB60	350	420	2920	3500
CB70	550	650	4625	5420
CB80	535	630	4460	5250
CB100	610	715	5085	5960
CB100A	-	595	-	4960
CB1025A	-	670	-	5585

- When dissolving chemicals, the following procedure is suggested. Warm water should be put into a suitable container. Slowly introduce the dry chemical into the water stirring at all times until the chemical is completely dissolved. Add the chemical slowly and in small amounts to prevent excessive heat and turbulence.

 **Caution**

Use of a suitable facemask, goggles, rubber gloves, and protective garments is strongly recommended when handling or mixing caustic chemicals. Do not permit the dry material or the concentrated solution to come in contact with skin or clothing.

- An overflow pipe should be attached to one of the top boiler openings and routed to a safe point of discharge. A relief or safety valve tapping is usually used.
- Water relief valves and steam safety valves must be removed before adding the boil-out solution so that neither it nor the grease which it may carry will contaminate these valves. Use care in removing and re-installing valves.

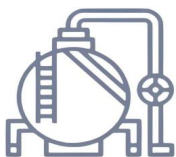
**NOTE:** Refer to Section 7.13 in chapter 7 for valve installation instructions.

- All valves in the piping leading to or from the system must be closed to prevent cleaning solution from getting into the system.
- Fill pressure vessel with clean water until the tops of the tubes are covered. Add the cleaning solution and then fill to the top. The temperature of the water used in this initial fill should be at ambient temperature.
- The boiler should then be fired intermittently at a low rate sufficient to hold solution just at the boiling point. Boil the water for at least five hours. Do not produce steam pressure.
- Allow a small amount of fresh water to enter the boiler to create a slight overflow that will carry off surface impurities.
- Continue to boil and overflow until the water clears. Shut the burner down.
- Let the boiler cool to 120° F or less, then drain using caution that the water is safely discharged.
- Remove hand hole plates and use a high pressure water stream to wash the waterside surfaces thoroughly.
- Inspect surfaces and if not clean, repeat the boil-out.
- After closing openings and re-installing safety or relief valves, fill the boiler and fire until the water is heated to at least 180° F to drive off any dissolved gases which might otherwise corrode the metal.

The above procedure may be omitted in the case of a unit previously used or known to be internally clean. However, consideration must be given to the possibility of contaminating materials entering the boiler from the system.

On a steam system, the condensate should be wasted until tests show the elimination of undesirable impurities. During the period that condensate is wasted, attention must be given to the treatment of the raw water used as makeup so that an accumulation of unwanted materials or corrosion does not occur. Follow the advice of your water treatment company.

On a hot water system, chemical cleaning is generally necessary and the entire system should be drained after treatment. Consult water treatment companies for recommendations, cleaning, compounds, and application procedures.



**Courtesy of: C3 Surplus LLC**  
**Surplus Industrial Superstore**  
**305-428-2777**  
**<https://www.c3surplus.com>**

---

## 2.7 — Washing Out

### 2.7.1 — Hot Water Boiler

In theory, a hot water system and boiler that has been initially cleaned, filled with raw water (and that water treated), and with no makeup water added, will require no further cleaning or treatment. However, since the system (new or old) may allow entrance of air and unnoticed or undetected leakage of water, introductions of raw water makeup or air may lead to pitting, corrosion, and formation of sludge, sediment, scale, etc. on the pressure vessel waterside.

If the operator is absolutely certain that the system is tight, then an annual waterside inspection may be sufficient.

If there is any doubt, then the pressure vessel waterside should be inspected no later than three months after initially placing the boiler into operation and periodically thereafter as indicated by conditions observed during inspections.

### 2.7.2 — Steam Boiler

No later than three months after initially placing the boiler into operation and starting service, and thereafter as conditions warrant, the pressure vessel should be drained after being properly cooled to near ambient temperature, hand hole covers removed, and waterside surfaces inspected for corrosion, pitting, or formation of deposits.

Upon completion of inspection, the pressure vessel interior should be flushed out as required with a high pressure hose. If deposits are not fully removed by flushing, this may require immediate consultation with your water consultant or feedwater treatment company, and in extreme cases, it may be necessary to resort to acid cleaning. Professional advice is recommended if acid cleaning is required.

These inspections will indicate the effectiveness of the feedwater treatment. The effectiveness of treatment, the water conditions, and the amount of fresh water makeup required are all factors to be considered in establishing frequency of future pressure vessel washout periods. The feedwater consultant or water treatment company service should include periodic pressure vessel inspection and water re-analysis.

---

## 2.8 — Blowdown: Steam Boiler

Boiler water blowdown is the removal of some of the concentrated water from the pressure vessel and its replacement with feedwater so that a lowering of the concentration in the boiler water occurs.

Solids are brought in by the feedwater even though this water is treated prior to use through external processes that are designed to remove unwanted substances which contribute to scale and deposit formations. However, none of these are in themselves capable of removing all substances and regardless of their high efficiency, a small amount of encrusting solids will be present in the boiler water.

Solids become less soluble in the high temperature of the boiler water and tend to crystallize and concentrate on heating surfaces. Internal chemical treatment is; therefore, required to prevent the solids from forming harmful scale and sludge.

Scale has a low heat transfer value and acts as an insulation barrier. This retards heat transfer, which not only results in lower operating efficiency and consequently higher fuel consumption, but more importantly, can cause

overheating of boiler metal. This can result in tube failures or other pressure vessel metal damage causing boiler downtime and costly repairs.

Scale is caused primarily by calcium and magnesium salts, silica, and oil. Any calcium and magnesium salts in the boiler water are generally precipitated by the use of sodium phosphate, along with organic materials, to maintain these precipitates or “sludge” in a fluid form. The solids such as sodium salts and suspended dirt do not readily form scale, but as the boiler water boils off as relatively pure steam, the remaining water is thicker with the solids. If this concentration is permitted to accumulate, foaming and priming will occur and the sludge can cause harmful deposits that bring about overheating of the metal.

The lowering or removal of this concentration requires the use of boiler water blowdown.

There are two principal types of blowdown: Intermittent manual blowdown and continuous blowdown.

### **2.8.1 — Manual Blowdown**

Manual or sludge blowdown is necessary for the operation of the boiler regardless of whether or not continuous blowdown is employed.

The blowdown tappings are located at the bottom or lowest part of the boiler so that in addition to lowering the dissolved solids in the pressure vessel water, it also removes a portion of the sludge which accumulates in the lower part of the vessel.

Equipment generally consists of a quick opening valve and a shutoff valve. These, along with the necessary piping, are not normally furnished with the boiler, but supplied by others. All piping must be to a safe point of discharge. Piping must be properly supported and free to expand.

### **2.8.2 — Continuous Blowdown**

Continuous blowdown is used in conjunction with a surface blow-off tapping (furnished on units 60” in diameter or larger) and is the continuous removal of concentrated water.

The surface blow-off opening, when furnished is on top center line of the pressure vessel and is provided with an internal collecting pipe terminating slightly below the working water level for the purpose of skimming surface sediment, oil, or other impurities from the surface of the pressure vessel water.

A controlled orifice valve is used to allow a continual, yet controlled, flow of concentrated water.

Periodic adjustments are made to the valve setting to increase or decrease the amount of blowdown in accordance with the test analysis.

The flow control valve and piping are generally provided by others. All piping must be to a safe point of discharge.

### **2.8.3 — Frequency of Manual Blowdown**

When continuous blowdown is utilized, manual blowdown is primarily used to remove suspended solids or sludge. The continuous blowdown removes sediment and oil from the surface of the water along with a prescribed amount of dissolved solids.

When surface or continuous blowdown is not utilized, manual blowdown is used to control the dissolved or suspended solids in addition to the sludge.

In practice, the valve(s) of the bottom blowdown are opened periodically in accordance with an operating schedule and/or chemical control tests. From the standpoint of control, economy and results, frequent short blows are preferred to infrequent lengthy blows. This is particularly true when suspended solids content of the water is high. With the use of frequent short blows a more uniform concentration of the pressure vessel water is maintained.

In cases where the feedwater is exceptionally pure, or where there is a high percentage of return condensate, blowdown may be employed less frequently since less sludge accumulates in the pressure vessel. When dissolved and/or suspended solids approach or exceed predetermined limits, manual blowdown to lower these concentrations is required.

It is generally recommended that a steam boiler be blown down at least once in every eight-hour period, but this may vary depending upon water and operating conditions. The blowdown amounts and a schedule should be recommended by a water treating company or a water consultant.

A hot water boiler does not normally include openings for surface blowdown and bottom blowdown since blowdowns are seldom practiced. The need remains to be alert to system water losses and corresponding amount of raw water makeup. A water meter is recommended for water makeup lines.

#### 2.8.4 — Manual Blowdown Procedure

Blowdown is most effective at a time when generation of steam is at the lowest rate since feedwater input then is also low providing a minimum dilution of the boiler water with low concentration feedwater.

Make sure blow-off piping, and tank, if used, are in proper operating condition and discharge vents clear of obstruction, and that waste is piped to a point of safe discharge.

Most blow-off lines are provided with two valves, generally a quick opening valve nearest the boiler and a slow opening globe type valve downstream. Two slow opening valves or tandem valves may be used. Valves will vary depending upon pressure involved and make or manufacture. If seatless valves are installed, follow the manufacturer's recommendations.

If a quick opening valve and globe type or slow opening valve are in combination, the former is normally opened first and closed last with blowing down accomplished with the globe or slow opening valve.

When opening the second or downstream valve, crack it slightly to allow the lines to warm up, then continue opening slowly.

#### Caution

Do not open the slow opening valve first and pump the lever action valve open and closed as water hammer is apt to break the valve bodies or pipe fittings.

The length of each blow should be determined by actual water analysis. Lowering the water in the gauge glass approximately 1/2" is often acceptable as a guide to adequate blow. However, this should not be interpreted as a rule since water analysis procedures should prevail. If the glass cannot be viewed by the party operating the valve, another operator should watch the glass and direct the valve operator.

Close the downstream (slow opening) valve first and as fast as possible. Then close the valve next to the boiler. Slightly crack the downstream valve and then close it tightly.



Under no circumstance should a blow-off valve be left open and the operator should never leave until the blowdown operation is completed and valves closed.

---

## 2.9 — Periodic Inspection

Insurance regulations or local laws will require a periodic inspection of the pressure vessel by an authorized inspector. Sufficient notice is generally given to permit removal of the boiler from service and preparation for inspection.

When shutting down, the load should be reduced gradually and the pressure vessel cooled at a rate that avoids damaging temperature differential that can cause harmful stresses. Vessels should not normally be drained until all pressure is relieved, again to prevent uneven contraction and temperature differentials that can cause expanded tubes to leak. Draining the unit too quickly may cause the baking of deposits that may be present on the heating surfaces. Some heat, however, may be desirable to dry out the interior of the boiler.

If the internal inspection is being made at the request of an authorized inspector, ask him if he desires to observe the conditions prior to cleaning or flushing of waterside surfaces.

Be certain that a supply of manhole and hand hole gaskets is available, along with any other gaskets or items needed to place the unit back into operation after inspection.

Have available information on the boiler design, dimensions, generating capacity, operating pressure or temperature, time in service, defects found previously, and any repairs or modifications. Also have available for reference records of previous inspections.

Be prepared to perform any testing required by the inspector including hydrostatic.

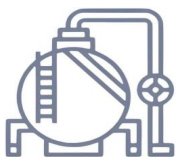
After proper cooling and draining of the vessel, flush out the waterside with a high pressure water hose. Remove any scale or deposits from the waterside surfaces and check for internal or external corrosion and leakage.

The fireside surface should also be thoroughly cleaned so that metal surfaces, welds, joints, tube ends, fitting, and any previous repairs can be readily checked.

Be sure that steam valves, system valves (hot water), feedwater valves, blow-off valves, all fuel valves, valves to expansion tank, and electrical switches are shut off prior to opening hand holes, manhole, and front or rear doors. Adequately vent the pressure vessel prior to entry. Flashlights rather than extension cords are recommended as a safety factor. Cleansers should preferably work in pairs.

Clean out the low water cutoff piping, the water level controls, and cross-connecting pipes. Replace water gauge glass and clean out water cocks and tri-cocks. Also check and clean drain and blowdown valves and piping.

Check all water and steam piping and valves for leaks, wear, corrosion, and other damage. Replace or repair as required.



**Courtesy of: C3 Surplus LLC**  
**Surplus Industrial Superstore**  
**305-428-2777**  
**<https://www.c3surplus.com>**

---

## 2.10 — Preparation for Extended Layup

Many boilers used for heating or seasonal loads or for standby service may have extended periods of non-use. Special attention must be given to these so that neither waterside nor fireside surfaces are allowed to deteriorate from corrosion.

Too many conditions exist to lay down definite rules. There are two methods of storage: wet or dry. Your water consultant or feedwater treating company can recommend the better method depending upon circumstances in the particular installation.

Whichever method is used, common sense dictates a periodic recheck of fireside and waterside conditions during the layup to allow variations from the above methods for special area or job site conditions.

Although pollution control regulations may continue to limit the permissible sulphur content of fuel oils, care must be taken to avoid corrosion problems that sulphur can cause, especially in a boiler that is seasonally shutdown. Dormant periods, and even frequent shutdowns, expose the fireside surfaces to condensation below the dew point during cooling. This moisture and any sulphur residue can form an acid solution. Under certain conditions, and especially in areas with high humidity, the corrosive effect of the acid will be serious enough to eat through or severely damage boiler tubes or other metal heating surfaces during the time that a boiler is out of service.

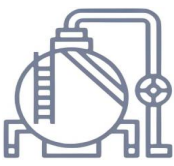
This condition does not generally occur during normal firing operation since the high temperature of operation vaporizes any condensation. However, proper boiler operation must be maintained, especially with a hot water boiler, to prevent the flue gases from falling below the dew point.

At the start of layup, thoroughly clean the fireside by removing any soot or other products of combustion from the tubes, tube sheets, and other fireside surfaces. Brushing will generally suffice. Sweep away or vacuum any accumulation. The fireside surfaces may be flushed with water. However, all moisture must be eliminated after flushing and the surface dried by blowing air or applying some form of heat. It is good practice to protect the cleaned surfaces by coating them with an anti-corrosive material to prevent rust.

To prevent condensation from forming in the control cabinet, keep the control circuit energized.

Dry storage is generally employed when the boiler will be out of service for some time or where freezing temperatures may exist. In this method the boiler must be thoroughly dried because any moisture would cause corrosion. Both fireside and waterside surfaces must be cleaned of scale, deposits, soot, etc. Steps must be taken to eliminate moisture by placing moisture-absorbing materials such as quick lime (at 2 pounds for 3 cubic feet of volume) or silica gel (at 5 pounds for 30 cubic feet of volume) on trays inside the vessel. Fireside surfaces may be coated with an anti-corrosive material or grease or tar paint. Refractories should be brushed clean and wash coated. All openings to the pressure vessel, such as manhole and hand holes, should be shut tightly. Feedwater and steam valves should be closed. Damper and vents should be closed to prevent air from reaching fireside surfaces. Periodic inspection should be made and absorption materials renewed.

Wet storage is generally used for a boiler held in standby condition or in cases where dry storage is not practical. The possibility of freezing temperatures must be considered. Care must again be taken to protect metal surfaces. Variables preclude definite recommendations. However, it is suggested that the pressure vessel be drained, thoroughly cleaned internally, and re-filled to overflowing with treated water. If deaerated water is not available, the unit should be fired to boil the water for a short period of time. Additional chemicals may be suggested by the water consultant to minimize corrosion. Internal water pressure should be maintained at greater than atmospheric pressure. Nitrogen is often used to pressurize the vessel. Fireside surfaces must be thoroughly cleaned and the refractory should be wash coated.



### 3.1 — Overview

This chapter outlines the electrical sequencing of various controls through the pre-purge, ignition, run, and shut-down cycles of the burner.

The program relay establishes the sequence of operation and directs the operation of all other controls and components to provide an overall operating sequence.

**NOTE:** The make or model of the program relay provided will vary depending upon job specifications. The following sequence applies regardless of the make or model. Please refer to the manufacturer's bulletin for specific information.

In the schematic type wiring diagram provided for the boiler, the grounded (common) side of the power supply is shown as a vertical line on the right side of the diagram. All inductive components (coils, solenoids, transformers, lights, etc.) are connected to it. The hot side of the power supply is shown as a vertical line on the left side of the electrical schematic. All the inductive components are connected to it through switches or contacts that permit the component to function when required.

**NOTE:** For an explanatory booklet on schematic wiring diagrams, request Cleaver-Brooks Bulletin C17-4095.

The burner and control system are in starting condition when the following conditions exist:

- Boiler water is up to correct level closing the low water cutoff switch.
- The low water light (panel) is off.
- The operating limit pressure control (steam boiler) or the operating limit temperature control (hot water boiler) and high limit pressure or temperature control are below their cutoff setting.
- All applicable limits are correct for burner operation.
- The load demand light glows.

All entrance switches are closed and power is present at the line terminals of:

- Blower motor starter
- Air compressor motor starter (if provided)
- Oil heater relay (if provided)

- Oil pump motor starter (if provided)

These sequences do not attempt to correlate the action of the fuel supply system or feedwater system except for the interlock controls that directly relate to the action of the program relay. Chapters 4 and 5 contain operating instructions and specific information on setting and adjusting the controls.

### 3.2 — Circuit and Interlock Controls

The burner control circuit is a two-wire system designed for 115 volt, single phase, 60 Hz, alternating current.

The electrical portion of the boiler is made up of individual circuits with controls that are wired in a manner designed to provide a safe workable system. The program relay provides connection points for the interconnection of these various circuits.

The controls used vary depending upon the fuel—oil or gas—and the specific requirement of applicable regulatory bodies. Refer to the boiler wiring diagram to determine the actual controls provided. The circuits and controls normally used in these circuits are listed below and referred to in the following sequence of operation.

Circuit	Components
Limit Circuit	<ul style="list-style-type: none"> <li>• Burner switch (BS)</li> <li>• Operating limit control (OLC), pressure or temperature</li> <li>• High limit control (HLC), pressure or temperature</li> <li>• Low water cutoff (LWCO)</li> <li>• Gas-oil selector switch (GOS), combination burner only</li> <li>• Oil drawer switch (ODS), oil burner</li> <li>• Low oil temperature switch (LOTS), No. 5 and 6 oil only</li> <li>• Low gas pressure switch (LGPS)</li> <li>• High gas pressure switch (HGPS)</li> <li>• Fuel valve interlock circuit</li> <li>• Main gas valve auxiliary switch (MGVAS)</li> <li>• Oil valve auxiliary switch (OVAS)</li> </ul>
Blower Motor Start Circuit	<ul style="list-style-type: none"> <li>• Blower motor starter (BMS)</li> <li>• Air compressor motor starter (ACMS), if provided</li> <li>• Air purge valve (APV), No. 5 and 6 oil only</li> </ul>
Running Interlock Circuit	<ul style="list-style-type: none"> <li>• Blower motor starter interlock (BMSI)</li> <li>• Combustion air proving switch (CAPS)</li> <li>• Atomizing air proving switch (AAPS)</li> </ul>
Low Fire Proving Circuit	<ul style="list-style-type: none"> <li>• Low fire switch (LFS)</li> </ul>
Pilot Ignition Circuit	<ul style="list-style-type: none"> <li>• Gas pilot valve (GPV)</li> <li>• Ignition transformer (IT)</li> <li>• Gas pilot vent valve (GPVV), if provided</li> </ul>

Circuit	Components
Flame Detector Circuit	<ul style="list-style-type: none"> <li>• Flame detector (FD)</li> <li>• Main Fuel Valve Circuit</li> <li>• Main gas valve (MGV)</li> <li>• Main gas vent valve (MGVV), if provided</li> <li>• Oil valve (OV)</li> <li>• Main fuel valve light (FVL)</li> </ul>
Firing Rate Circuit	<ul style="list-style-type: none"> <li>• Damper motor transformer (DMT)</li> <li>• Modulating damper motor (MDM)</li> <li>• Manual-automatic switch (MAS)</li> <li>• Manual flame control (MFC)</li> <li>• Modulating control (MC)</li> </ul>
High Fire Proving Circuit	<ul style="list-style-type: none"> <li>• High fire switch (HFS)</li> </ul>
Running Interlock and Limit Circuit	<ul style="list-style-type: none"> <li>• Low oil pressure switch (LOPS)</li> <li>• High oil pressure switch (HOPS)</li> <li>• High oil temperature switch (HOTS)</li> <li>• Auxiliary low water cutoff (ALWCO)</li> </ul>

To comply with requirements of insurance underwriters such as Factory Mutual (F.M.), Industrial Risk Insurers (I.R.I.), or others, additional interlock devices may be used in addition to those mentioned above.

## 3.3 — Sequence of Operation: Oil or Gas

On a combination fuel unit, the gas/oil switch must be set for the proper fuel.

The following sequence occurs with power present at the program relay (PR) input terminals and with all other operating conditions satisfied.

### 3.3.1 — Pre-Purge Cycle

When the burner switch (BS) is turned “on,” and controls wired in the “limit” and “fuel valve interlock” circuits are closed and no flame signal is present, the “blower motor start circuit” is powered energizing the blower motor starter (BMS). The load demand light (LDL) turns on. when firing oil, the air compressor motor starter (ACMS, if provided) is also powered. The air purge valve (APV, No. 5 and 6 oil only) remains de-energized.

At the same time, the program relay signals the modulating damper motor (MDM) to open the air damper. The damper begins to open and drives to its full open or high fire position. This allows a flow of purging air through the boiler prior to the ignition cycle.

On certain boilers the circuitry will include a high fire switch (HFS). The purpose of this switch is to prove that the modulating damper motor (MDM) has driven the damper to the open position during the pre-purge cycle. In this instance, the “high fire proving circuit” is utilized.

The controls wired into the “running interlock circuit” must be closed within 10 seconds after the start sequence. In the event any of these controls are not closed at this time, or if they subsequently open, the program relay will go into a safety shutdown.

At the completion of the high fire purge period, the program relay signals the modulating damper motor (MDM) to drive the air damper to its low fire position.

To assure that the system is in low fire position prior to ignition, the low fire switch (LFS) must be closed to complete the “low fire proving circuit.” The sequence will stop and hold until the modulating damper motor (MDM) has returned to the low fire position and the contacts of the low fire switch (LFS) are closed. Once the low fire switch is closed, the sequence is allowed to continue.

**NOTE:** The ignition trial cannot be started if flame or a flame simulating condition is sensed during the pre-purge period. A safety shutdown will occur if flame is sensed at this time.

### 3.3.2 — Ignition Cycle

The ignition transformer (IT) and gas pilot valve (GPV) are energized from the appropriate pilot ignition terminal.

**NOTE:** An oil fired burner may be equipped with an oil pilot rather than a gas pilot. The ignition sequence is identical for each.

The pilot flame must be established and proven by the flame detector (FD) within a 10 second period in order for the ignition cycle to continue. If for any reason this does not happen, the system will shut down and safety lockout will occur.

**NOTE:** Depending upon the requirements of the regulatory body, insurance, or fuel being burned, either the 10 or 15 second pilot ignition terminal may be used. Both provide the same function but differ in time interval allowed for proving main flame ignition. Refer to the boiler wiring diagram.

With a proven pilot, the main fuel valve(s) (OV or MGV) is energized. The main fuel valve light (FVL) in the panel turns on. The main flame is ignited and the trial period for proving the main flame begins. It lasts 10 seconds for light oil and natural gas, and 15 seconds for heavy oil. At the end of the proving period, if the flame detector still detects main flame, the ignition transformer and pilot valve are de-energized and pilot flame is extinguished.

#### Caution

If the main flame does not light, or stay lit, the fuel valve will close. The safety switch will trip to lockout the control. Refer to flame loss sequence section for description of action. The cause for loss of flame or any other unusual condition should be investigated and corrected before attempting to restart.

### 3.3.3 — Run Cycle

With main flame established, the program relay releases the modulating damper motor (MDM) from its low fire position to control by either the manual flame control (MFC) or the modulating control (MC) depending upon the position of the manual-automatic switch (MAS). This allows operation in ranges above low fire.

With the manual-automatic switch (MAS) set at automatic, subsequent modulated firing will be at the command of the modulating control (MC) which governs the position of the modulating damper motor (MDM). The air damper and the cam controlled metering valve are actuated by the motor through a linkage and cam assembly to provide modulated firing rates.

**NOTE:** Normal operation of the burner should be with the switch in the automatic position and under the direction of the modulating control. The manual position is provided for initial adjustment of the burner over the entire firing range. When a shutdown occurs while operating in the manual position at other than low fire, the damper will not be in a closed position thus allowing more air than desired to flow through the boiler. This subjects the pressure vessel metal and refractory to undesirable condition. The effectiveness of nozzle purging is lost on a No. 5 or No. 6 oil burner.

This is the end of the burner starting cycle. The LDL and FVL on the panel remain lit. Demand firing continues as required by load conditions.

### 3.3.4 — Burner Shutdown Post Purge

The burner will fire until steam pressure or water temperature in excess of demand is generated. With modulated firing, the modulating damper motor (MDM) should return to the low fire position before the operating limit control (OLC) opens. When the limit control circuit is opened, the following sequence occurs:

The main fuel valve circuit is de-energized causing the main fuel valve (MGV or OV) to close. The flame is extinguished. The control panel lights (LDL and FVL) are turned off. The blower motor continues to run to force air through the boiler for the post purge period.

On a No. 5 or 6 oil burner, the air purge valve (APV) is powered from the blower motor start circuit via the contacts of the air purge relay (APR) to provide an air purge of the oil nozzle. The damper motor returns to the low fire position if it is not already in that position.

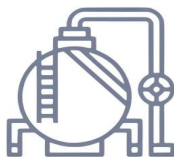
The blower motor start circuit is de-energized at the end of the post purge cycle and the shutdown cycle is complete.

The program relay is now in readiness for subsequent recycling and when steam pressure or water temperature drops to close the contacts of the operating control, the burner again goes through its normal starting and operating cycle.

---

## 3.4 — Flame Loss Sequence

The program relay will recycle automatically each time the operating control closes or after a power failure. It will lockout following a safety shutdown caused by a failure to ignite the pilot, or the main flame, or by loss of flame. Lockout will also occur if flame or flame simulating condition occurs during the pre-purge period.



Courtesy of: **C3 Surplus LLC**  
**Surplus Industrial Superstore**  
**305-428-2777**  
**<https://www.c3surplus.com>**

The control will prevent startup or ignition if limit circuit controls or fuel valve interlocks are open. The control will lockout upon any abnormal condition affecting air supervisory controls wired in the running interlock circuit.

**⚠ Caution**

The lockout switch must be manually reset following a safety shutdown. The cause for loss of flame or any unusual condition should be investigated and corrected before attempting to restart.

### 3.4.1 — No Pilot Flame

The pilot flame must be ignited and proven within a 10-second period after the ignition cycle begins. If not proven within this period, the main fuel valve circuit will not be powered and the fuel valve(s) will not be energized. The ignition circuit is immediately de-energized and the pilot valve closes, the reset switch lights and lockout occurs immediately.

The blower motor will continue to operate. The flame failure light and the alarm bell (optional) are energized 10 seconds later.

The blower motor will be de-energized. The lockout switch must be manually reset before operation can be resumed (see above Caution).

### 3.4.2 — Pilot But No Main Flame

When the pilot flame is proven, the main fuel valve circuit is energized. Depending upon the length of the trial-for-ignition period, the pilot flame will be extinguished 10 or 15 seconds later. The flame detecting circuit will respond to de-energize the main fuel valve circuit within 2 to 4 seconds to stop the flow of fuel. The reset switch lights and lockout occurs immediately. The blower motor will continue to operate.

The flame failure light and alarm bell (optional) are energized 10 seconds later.

The blower motor will be de-energized. The lockout switch must be manually reset before operation can be resumed (see above Caution).

### 3.4.3 — Loss of Flame

If a flame outage occurs during normal operation and/or the flame is no longer sensed by the detector, the flame relay will trip within 2 to 4 seconds to de-energize the fuel valve circuit and shut off fuel flow. The reset switch lights and lockout occurs immediately. The blower motor continues operation. The flame failure light and alarm bell (optional) are energized 10 seconds later.

The blower motor will be de-energized. The lockout switch must be manually reset before operation can be resumed (see above Caution).

If the burner will not start, or upon a safety lockout, the troubleshooting section in the operating manual and the technical bulletin should be referred to for assistance in pinpointing problems that may not be readily apparent.

The program relay has the capability to self-diagnose and to display a code or message that indicates the failure condition. Refer to the control bulletin for specifics and suggested remedies. Familiarity with the program relay and other controls in the system can be obtained by studying the contents of the manual and bulletin. Knowledge of the system and its controls will make troubleshooting much easier in the event it is necessary. Costly downtime



or delays can be prevented by systematic checks of the actual operation against the normal sequence to determine the stage at which performance deviates from normal. Following a routine may possibly eliminate overlooking an obvious condition, often one that is relatively simple to correct.

Remember that this is a safety device and for the most part it is doing its job when it shuts down or refuses to operate. Never attempt to circumvent any of the safety features.

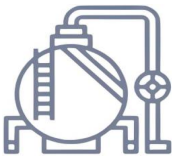
Preventive maintenance and scheduled inspection of all components should be followed. Periodic checking of the relay to see that a safety lockout will occur under conditions of failure to ignite either pilot or main flame, or from loss of flame is recommended.



**Courtesy of: C3 Surplus LLC**  
**Surplus Industrial Superstore**  
**305-428-2777**  
**<https://www.c3surplus.com>**



**Courtesy of: C3 Surplus LLC**  
**Surplus Industrial Superstore**  
**305-428-2777**  
**<https://www.c3surplus.com>**



## *Starting and Operating Instructions*

### 4.1 — General Preparation for Startup: All Fuels

Instructions in this chapter assume that installation is complete and that all electrical, fuel, water, and vent stack connections have been made.

The operator should be familiar with the burner, boiler, and all controls and components. Adjustment of the major components are given in Chapter 5 and should be reviewed prior to firing. The wiring diagram should also have been studied, along with the sequence in Chapter 3.

It is recommended that these starting instructions be read completely until they are thoroughly understood, **BEFORE ATTEMPTING TO OPERATE THE BOILER**, rather than performing each operation as it is read for the first time.

Verify supply of fuel and proper voltage. Check for blown fuses, open circuit breakers, dropped out overloads, etc. Check reset of all starters and controls having manual reset features. Check the lockout switch on the programmer and reset if necessary.

The boiler should be filled with water to the proper operating level using water of ambient temperature. Make sure that treated feedwater is available and used. In heating applications, the entire system should be filled and vented. Refer to Chapter 2 for water requirements. On a steam boiler, open the test valve to vent air displaced during filling. Leave the test valve open until escape of steam is noted after burner is operating.

#### **Caution**

Prior to firing a boiler, make sure that discharge piping from safety valves or relief valves, and discharge piping from all blowdown and drain valves is piped to a safe point of discharge, so that emission of hot water or steam cannot possibly cause injury to personnel or damage to equipment.

Check all linkage for full and free movement of the damper and metering valves and cams. This can be done by loosening the linkage at the damper motor connecting arm and manipulating linkage by hand.

Check for rotation of all motors by momentarily closing the motor starter or relay. Blower impeller rotation is counterclockwise when viewed from front of boiler. Air pump rotation is clockwise when viewed from its drive end.

Before operating the boiler feed pump or the oil supply pump, be sure all valves in the line are open or properly positioned.

For safety's sake, make a final pre-startup inspection, especially checking for any loose or incomplete piping or wiring or any other situations that might present a hazard.

---

## 4.2 — Control Settings: Steam and Hot Water

See Chapter 5 for adjustment instructions for the following controls.

Inspect operating limit control for proper setting:

1. The pressure control of a steam boiler should be set slightly above the highest desired steam pressure, but at least 10% lower than the setting of the safety valve.
2. The temperature control on a hot water boiler should be set slightly above the highest desired water temperature and within the limits of the pressure vessel.

Inspect the high limit control for proper setting:

1. On a high pressure steam boiler, this should be set approximately 10 lbs. above the operating limit pressure control setting, if feasible, or midway between operating limit pressure and safety valve setting. The setting on a low pressure steam boiler may be 2 or 3 lbs. above the operating limit setting but must exceed valve setting.
2. On a hot water boiler, the temperature control should be 5° - 10° above the operating limit temperature control setting.

Inspect the modulating control for proper setting. This control must be set and adjusted so that the modulating motor returns to low fire position before the operating limit control opens. It is further desirable to have its low point setting somewhat below the cut-in setting of the limit control so that the burner operates in low fire position for a brief period on each start rather than immediately driving to a high fire position.

**NOTE:** The settings of all the above controls may require some readjustment after the boiler is started and running for a short period. The scale settings on the controls are relatively accurate, but are principally for use as guides. Final adjustment should be based on and agree with the reading of the steam pressure gauge or the water temperature gauge.

Inspect the low water cutoff and pump control as well as the auxiliary low water cutoff (if equipped, optional). Normally, no adjustment is required since these controls are pre-set by the original manufacturer. Check for freedom of float movement. Float movement can be verified by observing the level of water in the gauge glass when the water supply has been cut off either by the stopping of the feed pump or by the closing of a valve, and the restarting of the pump or opening of the valve when water is drained from the pressure vessel. The importance of proper functioning of low water controls cannot be over emphasized. Make sure that the control and the piping is plumb.

The settings of controls relating to fuel, either oil or gas, are cover in subsequent sections.

In the event the boiler is equipped with optional control devices not listed here, be certain to ascertain that their settings are correct. If additional information is required, see your Cleaver-Brooks representative.

On initial startup, or whenever the boiler is placed into operation from a “cold” start, the manual-automatic selector switch should be set at “manual” and the manual flame control set at “close.” After the boiler is in operation and thoroughly warmed, the selector switch should be turned to “automatic,” so that the burner firing rate may be controlled by the modulating control in accordance with load demands. Close all power entrance switches (supplied by others).

---

### 4.3 — Gas Pilot

The gas pilot should be checked for satisfactory performance prior to initial firing. Follow the pilot flame adjustment instructions given in Chapter 5.

On initial starting attempts, several efforts might be required to accomplish bleeding time of the pilot line. While checking pilot adjustment, observe whether the pilot flame is extinguished promptly when the burner switch is opened. Linger flame is indicative of a leaking gas pilot valve and a condition requiring correction before proceeding.

---

### 4.4 — Atomizing Air

The supply and pressure of the atomizing air on an oil fired burner should be checked. Before starting, inspect the oil pump lube oil level. Add oil if necessary to bring the level to the midpoint or slightly higher in the sight glass. Use SAE 20 detergent oil of a grade mentioned in Chapter 7 and fill in accordance with instructions given there.

Check the oil level of the air intake strainer. The adjusting cock beneath the strainer should be fully open.

To verify air flow and pressure, place the run/test switch on the program relay to the test position. If this is a combination fuel burner, make sure that the gas/oil selector switch is set to “oil.” Turn the burner switch on. The burner will cycle to the low fire pre-purge position and stop there.

Observe the reading on the air pressure gauge. With no oil flow, the pressure should be a minimum of 7 psi.

If there is no pressure, determine the cause and correct it before proceeding. Check for obstructions in the air inlet line, incorrect rotation (air pump rotation is clockwise), or a loose oil nozzle or other leaks. If pressure is much higher without any oil flow, check for obstruction in the discharge line or at the oil nozzle.

The air pressure will increase when an oil flow exists. At low firing rate, the air pressure should be approximately 12 psi or slightly higher. If it is much higher, carefully adjust the cock in the intake line to limit the air pump output. The low fire flame shape will determine the amount of any necessary throttling.

At high fire the air pressure should not exceed 24 psi. Greater air pressure causes excessive wear of the air pump, increases lube oil usage, and can overload the motor.

<p><b>NOTE:</b> Abnormally high pressure indicated on the nozzle air pressure gauge is an indication that the burner nozzle has become clogged. In this event, check the nozzle and clean as necessary.</p>
---

After air flow has been verified, turn the burner switch off and return the run/test switch to the “run” position.

## 4.5 — Firing Preparations for No. 2 Oil: Series 100-200

Prior to initial firing, oil flow and pressure should be established and verified. Atomizing air pressure should also be established as outline in Section 4.4. The schematic flow diagram in Chapter 1 indicates the flow of fuel and atomizing air.

If the burner is a combination fuel model, make certain that the main gas shutoff cock is closed and set the gas/oil selector switch to “oil.” Insert the burner drawer gin into its most forward position and latch it in place.

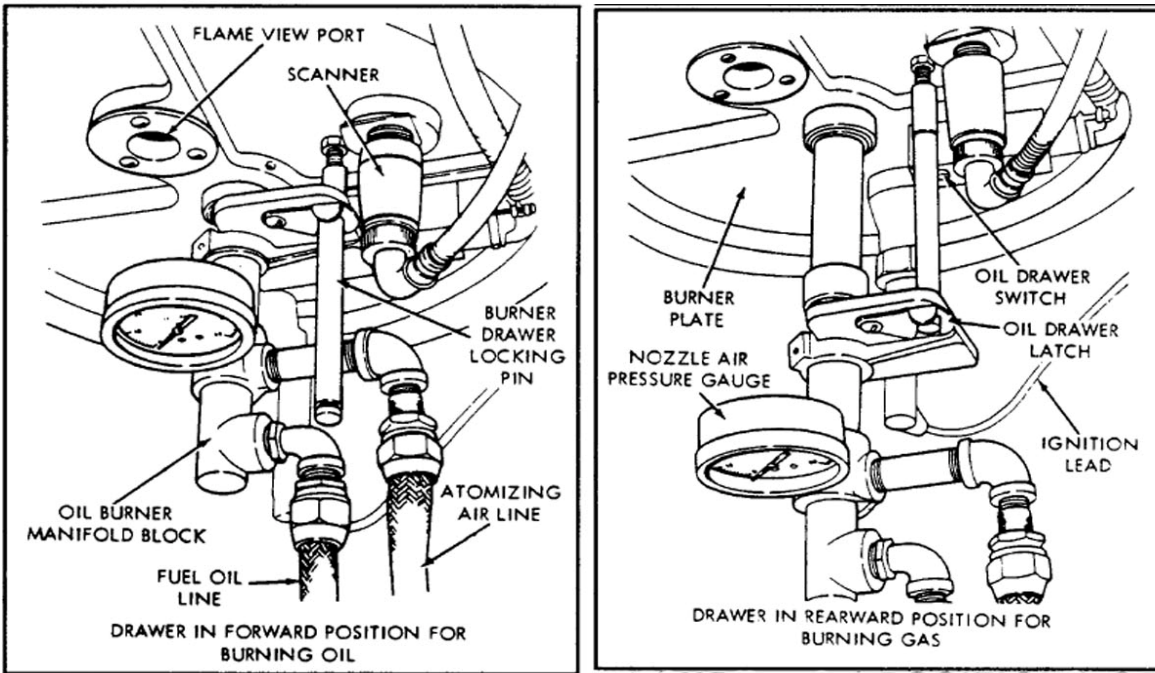


FIGURE 4-1. Positions of Burner Drawer for Oil and Gas

### 4.5.1 — Oil Flow

Open all valves in the oil suction and oil return lines.

If the oil supply tank is located above the level of the pump and flow to the pump is by gravity, then it will usually be necessary to vent the suction line to allow oil to fill the line. This can generally be accomplished by cracking a union fitting, or by opening the cap of the oil strainer using care to prevent spillage of oil. Tighten the fitting or cap as soon as oil flow appears.

If the oil supply tank is below the level of the oil pump, it is mandatory that the suction line to the pump be completely filled with oil prior to starting the pump to avoid the possibility of damage to the pump gears through operation without the lubrication afforded by the fuel oil. Non-lubricating fluids such as kerosene should not be used for priming.

Prior to priming the suction line and the initial start, check to make certain that all plugs, connections, etc., have been securely tightened to prevent leaks.

If the fuel oil supply originates from a pressurized loop, it is assumed that the pressure of the loop will be at a minimum of 75 psi. Boilers would not then have individual pumps furnished as standard equipment. Under these conditions the relief valve at the terminal block should be adjusted to the point where it becomes inoperative.

A standard equipped boiler has a selector switch incorporated in the oil pump motor starter. Momentarily energize the starter to check for proper pump rotation. With the rotation verified, operate the pump to determine that oil circulation exists. Observe the oil burner pressure gauge for indication that flow is established. If no pressure shows on this gauge after a few moments, stop the oil pump and re-prime. If the supply tank is lower than the pump, it is possible that the initial priming of the suction line, followed by operation of the pump, will not establish oil flow. This might be caused by obstruction in the suction line, excessive lift, inadequate priming, suction line leaks, etc. If oil flow is not readily established, avoid prolonged operation of the pump to minimize risk of damage to internal parts of the pump. If oil flow is not established after a second or third priming attempt, a full investigation is required to determine the cause.

A vacuum (or a compound pressure-vacuum) gauge should be installed at the suction port of the pump and its reading observed and recorded for future guidance. If a vacuum condition exists, this reading will reveal the tightness of the system. It is advisable to maintain the vacuum reading at less than 10" W.C. A vacuum in excess of this may allow oil to vaporize and cause cavitation, loss of prime, and unstable firing condition.

#### 4.5.2 — Oil Pressure

Oil supply pressure is regulated by adjusting the pressure relief valve at the oil terminal block. A pressure gauge should be installed in the terminal block and the relief valve adjusted to obtain a minimum reading of 75 psi when the burner is firing at maximum rate.

When oil is supplied from a pressurized loop to a multiple boiler installation, the relief valve in the loop should be properly adjusted to provide this reading. In this circumstance, the relief valve at the terminal block should be adjusted to the point where it will be inoperative (or removed and openings plugged). To render inoperative, turn adjusting screw in as far as possible.

Adjust the regulator in the fuel oil controller so that the burner oil gauge registers approximately 40 psi. The burner pressure gauge will indicate a lower reading when main flame is ignited and pressure will decrease slightly as the firing rate increases.

Final regulation of oil flow to the nozzle can be done later, if necessary, by adjusting the metering cam screws as outlined in Chapter 5.

Suggested oil pressures at high fire operation:

Oil Supply	75 psi
Oil Burner Pressure	40-50 psi

#### 4.5.3 — Starting

When all the conditions covered above and in Sections 4.1, 4.2, 4.3, and 4.4 are assured, the burner is ready for firing. Refer to Section 4.8 of this chapter for further starting and operating information.

## 4.6 — Firing Preparations for No. 4 Oil: Series 800-900

Prior to initial firing, oil flow, pressure, and temperature should be established and verified. Atomizing air pressure should also be established as outlined in Section 4.4. The schematic flow diagram in Chapter 1 indicates the flow of fuel and atomizing air.

If the burner is a combination fuel model, make certain that the main gas shutoff cock is closed and set the gas/oil selector switch to “oil.” Insert the burner drawer gun into its most forward position and latch it in place.

### 4.6.1 — Oil Flow

Open all valves in the oil suction and oil return lines. Momentarily energize the fuel oil pump starter to check for proper pump rotation. With rotation verified, prime the suction line strainer with oil and start the fuel oil pump by closing its power entrance switch. Observe the pressure gauge on the fuel oil controller for indication that oil flow is established. If no pressure shows after a few moments, stop the oil pump and re-prime. If oil flow is not established after priming the pump on one or more occasions, conditions preventing oil flow must be determined and corrected to avoid damage to the pump’s internal mechanism.

A vacuum (or a compound pressure-vacuum) gauge should be installed in the oil suction line and its reading observed and recorded for future guidance. This gauge reveals the tightness of the system.

### 4.6.2 — Oil Pressure


As soon as it is determined that oil is flowing through the controller, adjust the pressure relief valve if necessary to obtain 42 to 45 psi. The pressure will fluctuate slightly during the firing cycle. If it is erratic prior to firing or does not respond to adjustment, possibly air is trapped in the line or there may be a leak in the suction line. The tightness of the suction line can be determined by reference to a vacuum gauge. If air is trapped in the line, turn out the relief valve adjusting screw so that there is no pressure on the valve. This will generally permit the free flow of any trapped air through the valve. Turn the adjusting screw to obtain the necessary pressure.

If the preceding does not prove to be the problem, it is possible that foreign matter may have lodged under the seat of the back pressure regulator valve. In this case the valve will have to be disassembled and carefully cleaned. Final regulation of oil flow to the nozzle may be done later, if necessary, by adjusting the metering cam screws as outlined in Chapter 5.

After the burner is firing and with properly heated oil, further adjustments can be made, if necessary, to this valve.

### 4.6.3 — Oil Temperature

When oil flow is ascertained, turn the oil heater switch to “on.”

 **Caution**

Before turning on the oil heater switch, make certain that the heater shell is filled with fuel oil as indicated by a pressure reading on the fuel oil pressure gauge.

The electric oil heater has a built in adjustable thermostat. The normal temperature requirement is 100° F. Should adjustment be necessary, turn the adjusting screw and use the thermometer in the fuel oil controller as a guide to the proper temperature.



Suggested oil pressures at high fire operations:

Oil Supply	75 psi
Oil Burner Pressure	42-45 psi

#### 4.6.4 — Starting

When all of the conditions covered above and in Sections 4.1, 4.2, 4.3, and 4.4 are assured, the burner is ready for firing. Refer to Section 4.10 for further starting and operating information.

### 4.7 — Firing Preparations for No. 5 Oil: Series 300-500

Prior to initial firing, oil flow, pressure, and temperature should be established and verified. Atomizing air pressure should also be established as outlined in Section 4.4. The schematic flow diagram in Chapter 1 indicates the flow of fuel and atomizing air.

If the boiler is a combination fuel model, make certain that the main gas shutoff cock is closed and set the gas/oil selector switch to “oil.” Insert the burner drawer gun into its most forward position and latch it in place.

#### 4.7.1 — Oil Flow

Open all valves in the oil suction and oil return lines. Momentarily energize the fuel oil pump starter to check for proper pump rotation. With the rotation verified, prime the suction line strainer with oil and start the fuel oil pump by closing its power entrance switch. Observe the oil supply pressure gauge for indication that oil flow is established. If no pressure shows on the gauge after a few moments, stop the fuel oil pump and re-prime. Heavy oil in the storage tank must be at a temperature to provide oil viscosity that will permit flow through the oil pump and suction lines. If oil flow is not established after priming the pump on one or more occasions, conditions preventing oil flow must be determined and corrected to avoid damage to the pump’s internal mechanism.

A vacuum (or compound pressure-vacuum) gauge should be installed in the oil suction and its reading observed and recorded for future guidance. This gauge reveals the tightness of the system.

#### 4.7.2 — Oil Pressure

With flow established, check the oil pressure on the gauge at the oil heater. The pressure should be 75 psi.

This adjustment is regulated by the relief valve in the line to the oil heater. Make any initial adjustment necessary to this valve.

On a cold start, or with cold oil, it may be necessary to open the orifice valve on the fuel oil controller. This valve must be closed as soon as flow is established.

The pressure reducing valve on the fuel oil controller should be adjusted if necessary to obtain a pressure reading on the controller oil gauge of approximately 40-50 psi.

After the burner is firing and with properly heated oil, further adjustments can be made, if necessary, to these valves.

### 4.7.3 — Oil Temperature

When oil flow is established and regulated, turn the oil heater switch to “on.”

**Caution**

Before turning on the oil heater switch, make certain that the heater shell is filled with fuel oil as indicated by a pressure reading on the fuel oil pressure gauge.

The electric oil heater has a built-in adjustable thermostat. Turn the adjusting screw to maintain an oil temperature of approximately 140°-150° F.

**NOTE:** The temperatures listed are tentative. The composition of the fuel oil in a given grade can vary, necessitating a higher or lower preheating temperature. The viscosity of the oil at the nozzle should be less than 300 SSU and preferably less than 150 SSU. The actual temperature of the oil at the burner should be determined by flame appearance and good combustion based on a stack analysis. See Chapter 5 for additional information.

Close the manual bypass valve after temperature rise on the fuel oil controller thermometer is noted. Make certain that hot oil is moving through the controller. The orifice gate valve must also be closed. If the temperature drops, open the orifice gate valve until a rise is noted, then close it.

Final regulation of oil flow through the nozzle may be done later, if necessary, by adjusting the metering cam screws as outlined in Chapter 5.

Suggested oil pressures at high fire operation:

Oil Supply	75 psi minimum
Oil Burner Pressure	40-50 psi

### 4.7.4 — Starting

When all conditions covered above and in Sections 4.1, 4.2, 4.3, and 4.4 are assured, the burner is ready for firing. Refer to Section 4.10 for further starting and operation information.

## 4.8 — Firing Preparation for No. 6 Oil: Series 400-600

Prior to initial firing, oil flow, pressure, and temperature should be established and verified. Atomizing air pressure should also be established as outlined in Section 4.4. The schematic flow diagram in Chapter 1 indicates the flow of fuel and atomizing air.

If the boiler is a combination fuel model, make certain that the main gas shutoff cock is closed and set the gas/oil selector switch to “oil.” Insert the burner drawer gun into its most forward position and latch it in place.

### 4.8.1 — Oil Flow

Open all valves in the oil suction and oil return lines. Open the bypass valve on the fuel oil controller until oil flow is established. Normally, the orifice valve is left in a closed position. However, on cold starts, it may be opened for

brief periods to aid in establishing oil flow. The bypass and orifice valves must be returned to the closed position as soon as proper oil flow is established as indicated by a reading on the oil supply pressure gauge. Do not attempt to set pressures while valves are open.

Momentarily energize the fuel oil pump starter to check for proper pump rotation. With the rotation verified, prime the suction line strainer with oil and start the fuel oil pump by closing its power entrance switch. Observe the oil supply pressure gauge for indication that oil flow is established. If no pressure shows on the gauge after a few moments, stop the oil pump and re-prime. Heavy oil in the storage tank must be at a temperature to provide oil viscosity to permit flow through the oil pump and suction line. If oil flow is not established after priming the pump on one or more occasions, conditions preventing oil flow must be determined and corrected to avoid damage to the pump's internal mechanism.

A vacuum (or a compound pressure-vacuum) gauge should be installed in the oil suction line and its reading observed and recorded for future guidance. This gauge reveals the tightness of the system.

#### 4.8.2 — Oil Pressure

Oil pressure is regulated in several areas. The first is at the relief valve at the oil heater. This should be set so that at maximum firing rate a minimum reading of 75 psi is obtained on the oil supply pressure gauge.

The other pressure adjustments are to the regulators on the fuel oil controller. Adjust the fuel oil pressure regulator so that the burner oil gauge registers approximately 45 psi. Adjust the back pressure relief valve so that its gauge reads approximately 10 psi less than the burner gauge.

After the burner is firing, further adjustments can be made, if necessary, to these valves.

The pressure gauges will indicate lower readings when main flame is ignited. The pressure will decrease as the firing rate increases and vice versa. The pressure reading on the two gauges on the controller will, despite this fluctuation, retain a nearly constant difference of 10 psi.

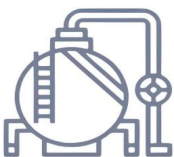
Final regulation of oil flow to the nozzle can be done, if necessary, by adjusting the metering cam screws as outlined in Chapter 5.

Suggested oil pressures at high fire operation:

Oil Supply Pressure Gauge	75 psi minimum at maximum firing rate
Oil Burner Pressure Gauge	40-50 psi
Oil Return Pressure Gauge	10 psi less than oil supply pressure

#### 4.8.3 — Oil Temperature

After determining that the heater shell is filled and that fuel oil circulation exists, turn the oil heater switch to "on." Adjust the electric oil heater thermostat to maintain oil temperature at approximately 200° F.



Courtesy of: **C3 Surplus LLC**  
**Surplus Industrial Superstore**  
**305-428-2777**  
<https://www.c3surplus.com>

---

**⚠ Caution**

---

Before turning on the electric oil heater switch, make certain that the heater shell is filled with fuel oil as indicated by a pressure reading on the fuel oil pressure gauge.

The electric heater on burners equipped for No. 6 fuel oil is sized so that it is capable of supplying heated oil at a rate no greater than that required for low fire operation and is primarily supplied for convenience on cold starts. Heating coils utilizing either steam or hot water are supplied to provide sufficient quantities of oil so that higher rates of firing can be accomplished once steam pressure or hot water is available. In normal operation, the thermostat governing the electric heating element is kept at a lower setting than the thermostat governing admission of steam to the heater, or of hot water circulation, so that heating is not performed electrically except when steam or hot water is not available.

Set the steam thermostat or the hot water thermostat to maintain an oil temperature of 220°-230° F. The electric heater will be turned off automatically as soon as steam or hot water provides heat.

**NOTE:** The temperatures listed are tentative. The composition of the fuel oil in a given grade can vary, necessitating a higher or lower preheating temperature. The viscosity of the oil at the nozzle should be less than 300 SSU and preferably less than 150 SSU. The actual temperature of the oil at the burner should be determined by flame appearance and good combustion based on a stack analysis. See Chapter 5 for additional information.

Close the manual bypass valve after temperature rise on the fuel oil controller thermometer is noted. Make certain that hot oil is moving through the controller. The orifice gate valve must also be closed. If temperature drops, open the orifice gate valve until a rise is noted, then close it.

Once the correct setting of the heater thermostats has been established, set the low oil temperature switch at a point approximately 30° lower than the normal burning temperature. If the system is equipped with a high oil temperature switch, this should be set to open at 20°-30° higher than normal burning temperature.

#### 4.8.4 — Starting

When all the conditions covered above and in Section 4.1, 4.2, 4.3, and 4.4 are assured, the burner is ready for firing. Refer to Section 4.10 of this chapter for further starting and operating information.

### 4.9 — Firing Preparations for Gas: Series 200-300-400-700-900

Prior to initial starting, check the linkage attached to the gas butterfly valve to see that movement is free from binding.

Verify the presence and availability of gas. On a new installation, representatives of the gas utility should be present when gas is first turned into the system to supervise purging of the new gas line unless they have already done so.

Determine that the pilot is operating properly as outlined in Section 4.3

Determine that sufficient pressure exists at the entrance to the gas train. This can be done by installing a test gauge downstream of the regulator.

The gas pressure regulator must be adjusted to the proper pressure level. Since this regulator is generally supplied by others, adjustment should proceed according to instructions supplied by its manufacturer.

It is necessary for the operator to know the burner requirements in gas quantity and pressure. This information can generally be found on the dimension diagram supplied for the particular installation. Should this information not be readily available, consult the Cleaver-Brooks Service Department and provide the boiler serial number. Chapter 5 contains additional information along with standard gas flow and pressure requirements. This section should be completely reviewed prior to startup.

If the burner is a combination fuel model, set the gas/oil switch to “gas.” Withdraw the oil burner gun and latch it in its rearward position.

On initial startup, it is recommended that the main gas shutoff cock remain closed until the programmer has cycled through pre-purge and pilot sequences. When the fuel oil light on the control panel comes on, observe the action of the motorized gas valve stem to determine that it opens when energized. As soon as this is confirmed, turn the burner switch “off” and let the programmer finish its cycle. Check to see that the gas valve has closed. Again turn the burner “on” and when the fuel valve light glows slowly open the main gas cock. Main flame should ignite unless there is air present in the line. If flame is not established within about 5 seconds, turn the burner switch “off” and allow the programmer to recycle normally for a new lighting trial. Several efforts may be necessary to “bleed” air from the line.

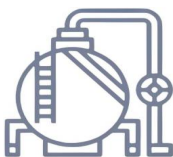
 **Caution**

Do not repeat unsuccessful lighting attempts without re-checking burner and pilot adjustments if lighting does not occur within 5 seconds after fuel introduction is verified or can be reasonably assumed.

**NOTE:** The burner and control system is designed to provide a “pre-purge” period of fan operation prior to establishing ignition spark and pilot flame. Do not attempt to alter the system or to take any action that might circumvent this feature.

Once the main flame is established, observe that it is extinguished promptly when the burner is shut down. The flame may continue to burn for a second or two after normal shutdown due to the gas remaining downstream from the fuel valve. If the flame continues to burn for a longer period or during blower motor spindown, immediately turn the burner switch off and close the main gas cock. Investigate and correct the cause of valve leakage before relighting the burner. The main gas valve is tight seating provided nothing prevents tight closure. Foreign material may be present in either new or renovated gas lines unless adequate care is taken in cleaning and purging.

When the conditions covered above and in Sections 4.1, 4.2, and 4.3 are assured, the burner is ready for firing. Refer to Section 4.10 for further starting and operating information.



**Courtesy of: C3 Surplus LLC**  
**Surplus Industrial Superstore**  
**305-428-2777**  
**<https://www.c3surplus.com>**

---

## 4.10 — Startup, Operating, Shutdown: All Fuels

Depending upon the fuel being burned, the applicable previous sections in this chapter should be reviewed for preliminary instructions.

When firing with oil make certain that the burner gun is in its most forward position and latched in place. When firing with gas, the burner gun should be properly withdrawn and latched in place. The fuel selector switch should be accordingly set to either “oil” or “gas.”

Set the manual-automatic switch to “manual” and turn the manual flame control to “close.”

Turn the burner switch to “on.” The load demand light should glow. the low water level light should remain out, indicating a safe water level in the boiler.

The programmer is now sequencing. See Chapter 3 for sequence details.

**NOTE:** On an initial starting attempt, several efforts might be required to accomplish “bleeding” of fuel lines, main, or pilot. If ignition does not then occur, do not repeat unsuccessful attempts without re-checking the burner and pilot adjustment.

On ignition failure, the flame failure light will glow and the blower will purge the boiler of unburned fuel vapors before stopping. After ignition failure, wait a few moments before re-setting the lockout switch.

---

### Caution

---

Do not re-light the pilot or attempt to start the main burner, either oil or gas, if combustion chamber is hot and/or if gas or oil vapor combustion gases are present in the furnace or flue passages. The burner and control system is designed to provide a “pre-purge” period of fan operation prior to establishing ignition spark and pilot flame. Do not attempt to alter the system or take any action that might circumvent this feature.

After main flame ignition, the burner should be left on manual control at its low fire setting (that is, with manual flame control at “close”) for about 30 minutes or until the boiler is properly warmed, unless it reaches its normal operating pressure or temperature sooner.

In the case of a steam boiler, CLOSE THE TEST VALVE when steam begins to appear.

A hot water boiler must have a continuous flow of system water through the vessel during the warm-up period. The entire water content of the system and boiler must be warmed prior to increasing fuel input.

If flame at low fire setting is insufficient to reach normal operating pressure or temperature after 30 minutes, gradually increase the firing rate by turning the manual flame control in one point increments to no higher than the mid-point between close and open. Operate at this increased fuel input rate for a period of time until an increase is noted in pressure or temperature. Sustained operation of the boiler should never be maintained when the manual control is set beyond midpoint.

After the unit is thoroughly warmed, turn the manual flame control to high fire. At this point a combustion analysis should be made, with instruments, and fuel flow regulated as required. Refer to adjustment procedures in Chapter 5. After making the high fire adjustment manually, position the burner over the range from high to low fire, stopping at intermediate points, analyzing combustion gases, and adjusting as required.

To properly perform this testing and adjusting, it is necessary that the burner be allowed to fire at maximum rate sufficiently long enough to achieve desired results.

#### 4.10.1 — Operating

Normal operation of the burner should be with the switch in the automatic position and under the direction of the modulating control. The manual position is provided for initial adjustment of the burner over the entire firing range. When a shutdown occurs while operating in the manual position at other than low fire, the damper will not be in a closed position, thus allowing more air than desired to flow through the boiler. This subjects the pressure vessel metal and refractory to undesirable conditions.

With the switch set at “auto,” the burner will operate on a modulating basis according to the load demand.

The burner will continue to operate with modulated firing until operating limit pressure or temperature is reached, unless:

- The burner is manually turned “off.”
- Low water condition is detected by the low water level control.
- Current or fuel supply is interrupted.
- Pressure of combustion (or atomizing) air drops below minimum level.

**NOTE:** There can be other reasons for shutdown such as motor overload, flame outages, tripped circuit breakers, blown fuses, or through other interlock devices on the circuitry.

When the burner is shut down normally, by either the operating limit control or by manually switching the burner off, the load demand light no longer glows.

Shutdown through conditions causing safety or interlock controls to open will actuate the flame failure light (and alarm, if so equipped) and the load demand light will remain lit. The cause of this type of shutdown will have to be located, investigated, and corrected before operation can be resumed.

#### 4.10.2 — Shutdown

When the operating limit control setting is reached to open the circuit or if the burner switch is turned “off,” the following sequence occurs.

The fuel valve(s) is de-energized and the flame extinguished. The timer begins operation and the blower motor continues running to force air through the furnace in the post-purge period.

At the end of the programmed post-purge period, the blower motor is de-energized. The air pump motor of an oil fired burner is also de-energized. The timer has returned to its original starting position and stops. The unit is ready to re-start.

#### Caution

It is advisable to check for tight shutoff of fuel valves. Despite precautions and strainers, foreign material in either new or renovated fuel lines may lodge under a valve seat preventing tight closure. This is especially true in new installations. Promptly correct any conditions causing leakage.

---

## 4.4 — Control Operational Test and Checks

Proper operation of the various controls should be verified and tested when the boiler is initially placed into service or whenever a control is replaced. Periodic checks should be made thereafter in accordance with a planned maintenance program.

The operating limit control may be checked by allowing steam pressure or water temperature to increase until the burner shuts down. Depending upon the load, it may be necessary to manually increase the firing rate to raise steam pressure to the burner shutoff point. If the load is heavy, the header valve can be closed or throttled until the pressure increases. Observe the steam gauge to check the cutoff pressure as the operating limit control shuts the burner down. Open the header valve to release steam pressure or vent steam and check the cut-in setting as the burner restarts. Check the modulating control for desired operating pressure range. See Chapter 5 for instructions on the adjustment controls.

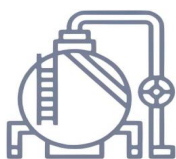
Water temperature, on a hot water boiler that may be operating at less than full load, may be raised by manually increasing the firing rate until the burner shuts down through the action of the operating limit control. Observe the thermometer to verify the desired settings at the point of cut-out and again when the burner restarts. Return the manual-automatic switch to “automatic” and check the modulating control for the desired temperature range. See Chapter 5 for instructions on the adjustment of the controls.

Check the proper operation and setting of the low water cut-off (and pump operating control, if used).

Proper operation of the flame failure device should be checked at time of starting and at least once a week thereafter. Refer to Chapter 7 for information on flame safety checks. Check the program relay's annunciation of any system failure. Observe the promptness of ignition of the pilot flame and the main flame.

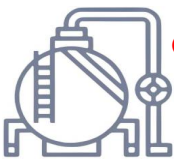
Check for tight shutoff of all fuel valves. Despite precaution and strainers, foreign material may lodge under a valve seat preventing tight closure. Promptly correct any conditions causing leakage.

Refer to adjustment procedures and maintenance instructions give in Chapters 5 and 7.



**Courtesy of: C3 Surplus LLC**  
**Surplus Industrial Superstore**  
**305-428-2777**  
**<https://www.c3surplus.com>**





---

## 5.1 — Overview

While each boiler is tested for correct operation before shipment from the factory, variable conditions such as burning characteristics of the fuel and operating load conditions may require further adjustment after installation to assure maximum operating efficiency and economy.

A combustion efficiency analysis made during the initial startup will help to determine what additional adjustments are required in a particular installation.

Prior to placing the boiler into service, a complete inspection should be made of all controls, connecting piping, wiring, and all fastenings such as nuts, bolts, and setscrews to be sure that no damage or mis-adjustments occurred during shipment and installation.

The adjustment procedures in this chapter apply to standard components furnished on steam or hot water boilers fired with gas and/or the various grades of oil.

Contact your Cleaver-Brooks representative or the Cleaver-Brooks Service Department for recommendations covering special controls that are not included in this chapter.

---

## 5.2 — Linkage: Modulating Motor and Air Damper

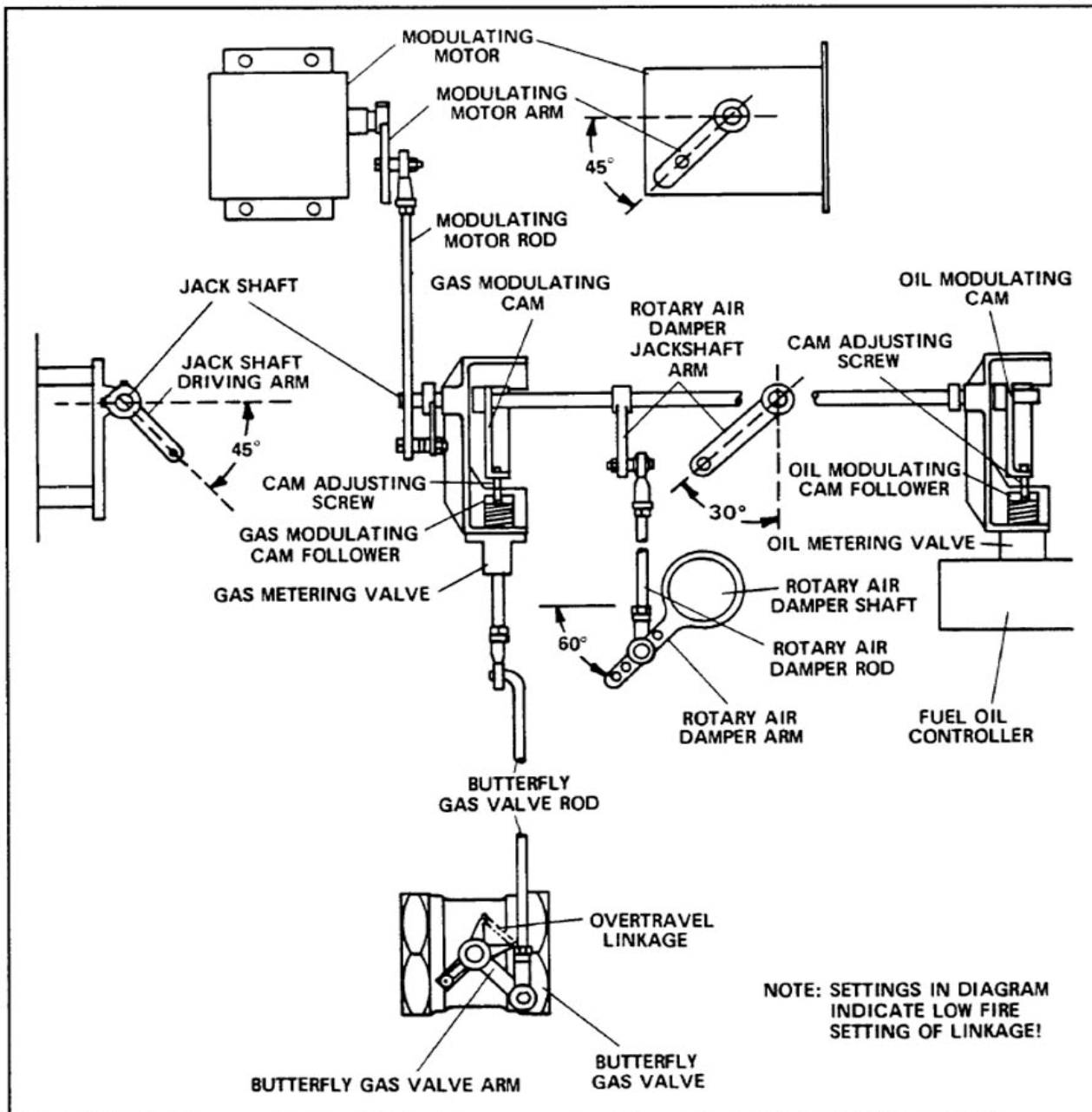
The linkage consists of various arms, connecting rods, and swivel ball joints that transmit motion from the modulating motor to the metering cam(s), to the rotary air damper, and to the gas butterfly valve, if used.

When properly adjusted, a coordinated movement of the damper and metering cams within the limits of the modulating motor travel is attained to provide proper fuel-air ratios through the firing range.

In linkage adjustments there are several important factors that must serve as guides:

- The modulating motor must be able to complete its full travel range. Restrictions will cause definite damage to this motor.
- Initial adjustment should be made with the motor in full closed position, that is with the shaft on the power end of the motor in its most counterclockwise position.

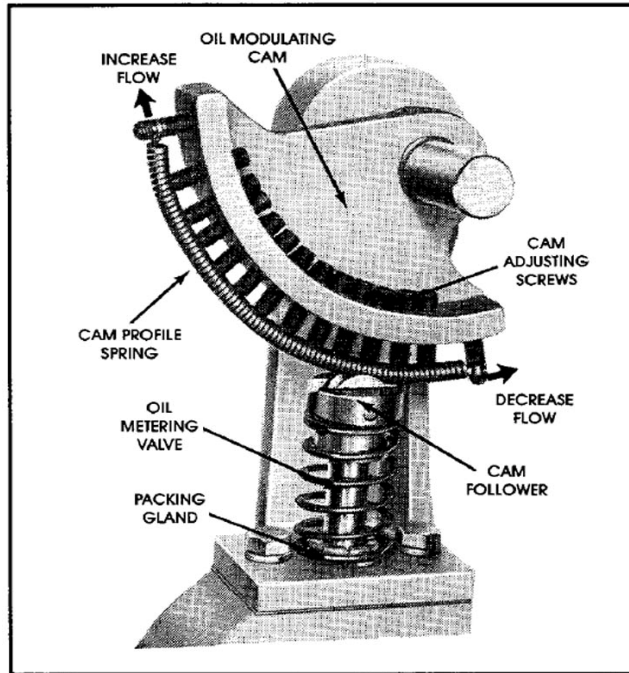
- The closer the connector is to the drive shaft the less the arm will travel, while the closer the connector is to the driven shaft the farther that arm will travel.
- Over-travel linkage, where used, should not be required to extend its spring to fullest stretch.



**FIGURE 5-1. Complete Linkage Assembly: Combination Gas and Oil**

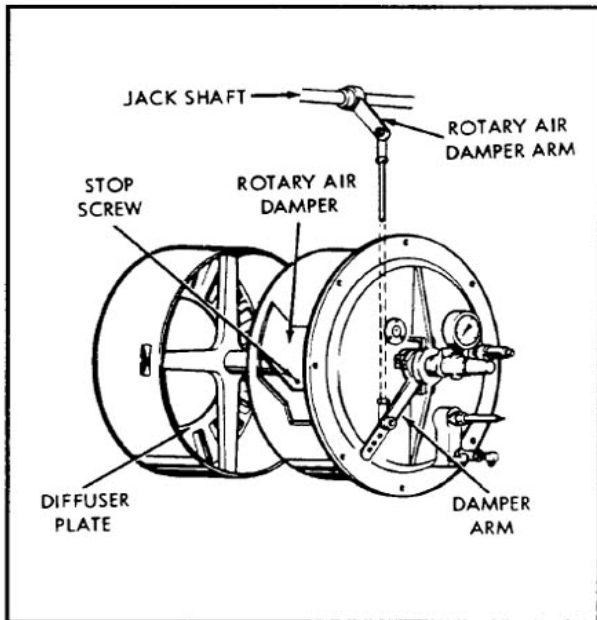
With the modulating motor in the low fire position, the arm on its shaft should be at an angle of  $45^\circ$  below the horizontal. The driven arm on the jackshaft should be parallel to this. Secure both arms and fit the connecting linkage rod in place between them.

Position the oil and/or gas modulating cams on the jackshaft so that the cam follower assembly is at its lowest point.



**FIGURE 5-2. Modulating Cam**

In this position, fuel delivery is at low fire rate. Secure cams with the setscrews.



**FIGURE 5-3. Rotary Air Damper**

The stop screw in the rotary air damper limits damper travel at both closed (low fire) and fully opened (high fire) positions. This screw is provided so that it is possible to tell, even with the burner in place, whether the damper rotor is in fully opened or closed position by rotating the damper open and closed by means of the damper arm. Normally, the rate of flow of air through the damper with the rotor in low fire position is about one-third of maximum.

The amount of angular movement controlling the rate of air flow is determined by the location of the ends of the rotary air damper rod in both the jackshaft arm and the air damper arm.

When the air damper is in low fire position, both the jackshaft arm and the rotary air damper arm should make an angle of approximately  $60^\circ$  below the horizontal. This is to insure that the angular movement of the damper starts slowly, increasing in speed as the high fire position is approached.

Prior to initially firing a boiler it is advisable to check for free movement of the linkage. The damper motor must be allowed to complete its full stroke and the damper must move from low to high fire position.

Adjustment of linkage connected to a gas butterfly valve is described in Section 5.17.

---

### 5.3 — Modulating Motor: Honeywell M954B or M954C

The modulating motor used in this application has a  $90^\circ$  shaft rotation. The motor manufacturer also provides a 160 stroke model for other applications. If a replacement is not obtained from a Cleaver-Brooks Service-Parts Agency, it may have an incorrect stroke. To prevent damage, determine the  $90^\circ$  stroke prior to installing a replacement.

This may be determined either by visual inspection of the power end shaft or by powering the motor and connecting terminal R-B to actually determine the stroke as the motor drives to an open position.

The closed position of the motor (normal condition of replacement motor) is the limit of counterclockwise rotation as viewed from the power end of the motor. In this position the flat part of the shaft is  $45^\circ$  from the horizontal on  $90^\circ$  stroke motors and  $10^\circ$  from horizontal on  $160^\circ$  stroke motors.

If adjustment to the stroke is required, refer to the manufacturer's Technical Bulletin. The motor may be damaged if it is unable to complete its full stroke.

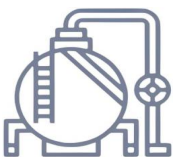
---

### 5.4 — Modulating Motor Switches: Low and High Fire

The modulating motor contains either one or two internal switches depending upon application. These single pole double throw micro-switches are actuated by adjustable cams attached to the motor shaft.

Factory replacement motors have the cams preset. The low fire start switch is set to make the red and yellow leads at approximately  $8^\circ$  on motor closing. The high fire purge air proving switch (M954B motor) is set to make red and blue tracer leads at approximately  $60^\circ$  on motor opening. Normally, these settings are left as is but job conditions may require readjustment.

If the cams require adjustment or resetting, follow the instructions in the manufacturer's Technical Bulletin.



**Courtesy of: C3 Surplus LLC**  
**Surplus Industrial Superstore**  
**305-428-2777**  
**<https://www.c3surplus.com>**

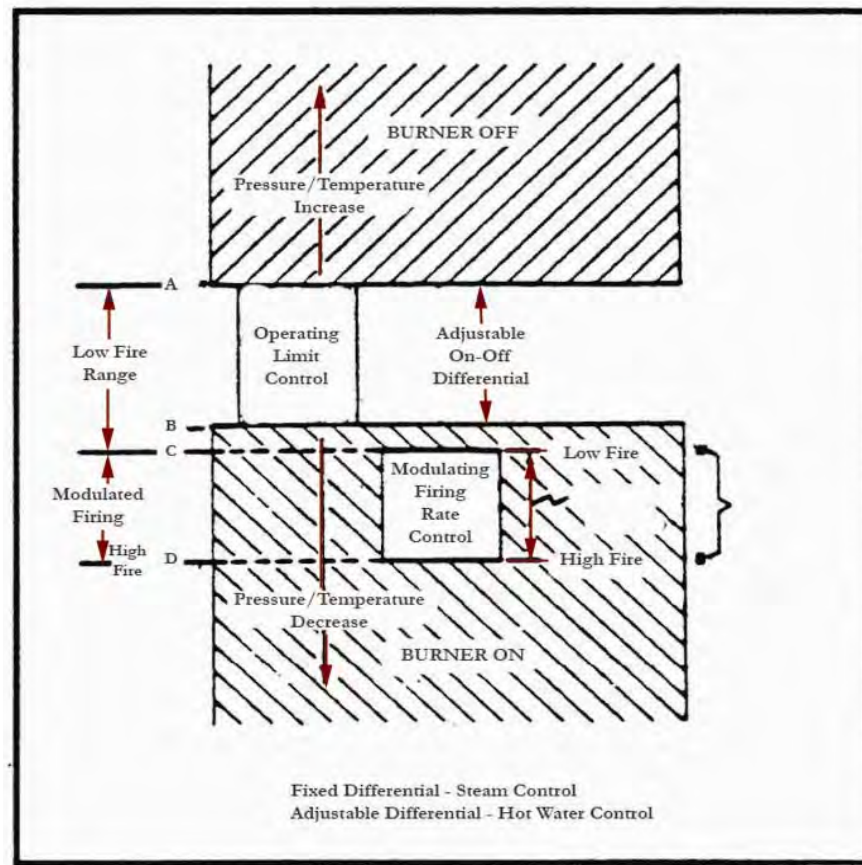
## 5.5 — Burner Operating Controls: General

In general, when adjusting controls check to see that they are level, especially those containing mercury switches. On temperature sensing controls, make sure that the bulb is properly bottomed in its well and that connecting tubing is not kinked.

Controls are carefully calibrated during their manufacture and do not normally require re-calibration. The dial settings are generally quite accurate although it is not unusual to have a slight variation between a scale setting and an actual pressure gauge or thermometer reading and to readjust the control setting to agree with these readings. This is based, however, on pressure gauges and thermometer being accurate.

Burner controls properly set to match load demands will provide operational advantages and achieve the following desirable objectives:

- The burner will be operating in low fire position prior to shut down.
- The burner will operate at low fire for a brief period on each start during normal operation.
- Eliminate frequent burner on-off cycling.



**FIGURE 5-4. Operating Control and Modulating Actions**

Figure 5-4 depicts a typical relationship of the setting of the operating limit control and the modulating control. Please note that this is not drawn to any scale. The burner will be “on” whenever the pressure or temperature is below point B and “off” whenever pressure or temperature is above point A. The distance between points A and B represents the “on-off” differential of the operating limit control.

In normal operation, the burner will shut down whenever the pressure or temperature reaches setting A. The switch in the operating limit control will open. As the pressure or temperature drops back to B, the switch makes and the burner will restart. The modulating control will be calling for the modulating motor to be in low fire position at this point. If the load exceeds this low fire input, the modulating control will respond to increase the firing rate proportionately as pressure or temperature falls toward point D. The modulating motor will stop at any intermediate point between C and D whenever the fuel input balances the load requirement. As the load requirement changes, the firing rate will change accordingly. This is referred to as modulated firing.

Point D represents the maximum firing rate of the burner. In the event pressure or temperature drops while the burner is firing at its maximum input, this is indicative that the load exceeds the generating rate of the boiler.

Although a gap is shown between B and C, these points may well coincide if required by load conditions. When set as shown, the burner will be in a low fire position upon a restart and will fire at that rate for a short period of time before falling pressure or temperature requires an increase in the firing rate. From this illustration it can be seen that this desirable objective will not be attained if setting C overlapped point B. In that event, upon a restart, the burner would drive to a higher firing position immediately after main flame was proven, and the brief period of low heat input would not occur. Actual settings will depend greatly upon load conditions which will affect the amount of differential permitted the operating limit control and to the gap, if any, between B and C.

When firing a cold boiler, it is recommended that the burner be kept under manual flame control until normal operating pressure or temperature is approached. The size of the flame may be manually and gradually increased to build up pressure or temperature. If the burner is not under manual control on a cold start, it will immediately move to high fire as soon as the program control releases the circuit that holds the burner in low fire during ignition. The modulating control will be calling for higher fire and the burner will move to that position as rapidly as the damper motor can complete its travel. This rapid heat input can subject the pressure vessel metal and refractory to undesirable conditions.

Any control setting must not cause the boiler to operate at or in excess of the safety valve setting. Settings that do not exceed 90% of the valve setting are recommended, with lower settings greatly desirable if load conditions permit. Avoid having the operating pressure too near the valve set pressure, because the closer the operating pressure is to the valve pressure, the greater the possibility of valve leakage. Continued leakage, however slight, will cause erosion and necessitate early valve replacement. The control settings on a hot water boiler must be within the temperature and pressure limits of the boiler.

Ideally, the burner operating controls should be set under actual load conditions. Often especially on new construction, the boiler is initially started and set to operate under less than full load requirements. As soon as possible thereafter the controls should be reset to provide maximum utilization of the modulating firing system.

To accomplish this, and assuming that air/fuel combustion ratios have been set, make approximate adjustments to the controls to bring the boiler pressure or temperature to meet the load requirements.

To properly set the modulating control, carefully adjust it under load conditions, until the load is maintained with the burner firing at a steady rate. The firing rate at that point may be full high fire or slightly less, depending upon the relationship of the boiler size to the load.

When the modulating control is set in this manner and if the burner is in full high fire, the scale setting of the modulating pressure control on a steam boiler will have a reading that indicates the low point of the modulating range. This fixed differential range is described later in this section. The scale setting of the modulating temperature con-

trol on a hot water boiler will have a reading that indicates the midpoint of the modulating range. This is also described later.

The operating limit control should now be adjusted and its differential established. See directions later in this section for the mechanics of adjusting. In an installation that does not require a very close control of steam pressure or water temperature, this adjustable differential should be set as widely as conditions permit, since this will provide less frequent burner cycling.

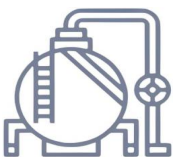
The high limit control provides a safety factor to shut the burner off in the event the operating limit control should fail to do so. The setting of this control should be sufficiently above the operating limit control to avoid nuisance shutdowns. The setting, however, must be within the limits of the safety valve settings and preferably not exceed 90% of the valve setting. The control requires manual resetting after tripping.

In the setting of these controls, consideration must be given to the time required for a burner restart. Upon each start, there is a pre-purge period of some length, plus the fixed time required for the proving of the pilot and main flame. This, plus approximately 1/2 minute required for damper motor travel from low to high fire, may allow pressure or temperature to drop below desirable limits.

The mechanics of setting the controls:

Control	Setting
1. Modulating Pressure Control: Steam, Honeywell L91A	Turn the adjusting screw until the indicator is opposite the low point of the desired modulating range. Modulated firing will range between this point and a higher point equal to the modulating range of the particular control. In 0-15 psi controls, the range is 1/2 lb.; in 5-150 psi controls, the range is 5 lbs.; in 10-300 psi controls, the range is 12 lbs.  <b>NOTE:</b> To prevent burner shutdown at other than low fire setting, adjust the modulating pressure control to modulate to low fire BEFORE the operating limit pressure control shuts off the burner.
2. Operating Limit Pressure Control: Steam, Honeywell L404A	Set "cut-out" (burner off) pressure on the main scale using the large adjusting screw. Set the differential on the short scale by turning the small adjusting screw until the indicator points to the desired difference between cut-out and cut-in pressures. The "cut-in" (burner on) pressure is the cut-out pressure MINUS the differential. The cut-out pressure should not exceed 90% of the safety valve setting.
3. High Limit Pressure Control: Steam, Honeywell L404C	Set "cut-out" (burner off) pressure on scale using the adjusting screw. The control will break a circuit when pressure reaches this point. The setting should be sufficiently above the operating limit pressure control to avoid shutdowns, and preferably not exceed 90% of the safety valve setting. This control requires manual resetting after tripping on a pressure increase. To reset, allow pressure to return to normal and then press the reset button.
4. Modulating Temperature Control: Hot Water, Honeywell T991A	Turn the knob on front of the case until the pointer indicates desired setpoint temperature. This is the center point of a proportional range. The control has a 3° to 30° differential and may be adjusted to vary the temperature range within which modulating action is desired. With the cover off, turn the adjustment wheel until the pointer indicates the desired range.  <b>NOTE:</b> To prevent burner shutdown at other than low fire setting, adjust the modulating temperature control to modulate to low fire BEFORE the operating limit temperature control shuts off the burner.

Control	Setting
5. Operating Limit Temperature Control: Hot Water, Honeywell L4008A	Set "cut-out" (burner off) temperature on scale by inserting a screwdriver through the cover opening to engage the slotted head adjusting screw. The "cut-in" (burner on) temperature is the cut-out temperature MINUS the differential. The differential is adjusted from 5° to 30° F.
6. High Limit Temperature Control: Hot Water, Honeywell L4008E	Set the "cut-out" (burner off) temperature on scale using the adjusting screw. This control will break the circuit and lock out on a rise in water temperature above the setting. The setting should be sufficiently above the operating limit temperature to avoid unnecessary shutdowns. On a 30 lb. hot water boiler, the setting is not to exceed 240° F. The control requires manual resetting after tripping on a temperature increase. To reset, allow water temperature to drop below the cut-out setting less the differential, and then press the manual reset button.
7. Low Water Cut-Off Devices: Steam and Hot Water	No adjustment is required since these controls are preset by the original manufacturer. However, if water level is not maintained, inspect devices immediately and replace as required.



Courtesy of: **C3 Surplus LLC**  
**Surplus Industrial Superstore**  
**305-428-2777**  
**<https://www.c3surplus.com>**



Control	Setting
8. Combustion air Proving Switch: Honeywell C645A	<p>Air pressure against the diaphragm actuates the switch which, when made, completes a circuit to prove the presence of combustion air. Since the pressure of the combustion air is at its minimum value when the damper is full open, the switch should be adjusted under that situation. It should be set to actuate under a condition of minimum pressure, but not too close to that point to cause nuisance shutdowns.</p> <p>The test switch on the program relay should be set to TEST. Turn the burner switch on. The blower will start (provided that all limit circuits are completed) and the programmer will remain in the low fire (damper closed) portion of the pre-purge.</p> <p>To have the modulating damper motor drive to high fire (damper open), remove the cover from the motor and remove the wire from terminal W.</p> <p>Slowly turn down the air switch adjusting screw until it breaks the circuit. At this point the programmer will lockout and it must be manually reset before it can be restarted. Add a half turn or so to the adjusting screw to remake its circuit.</p> <p>Recycle the program relay to be sure that normal operation is obtained. Replace the wire on terminal W and reinstall the cover. Return the test switch to the RUN position.</p> <p><b>NOTE:</b> On an oil fired boiler, the atomizing air proving switch (AAPS) must also be made. On a combination fuel fired burner, the fuel selector switch could be set at “gas” to eliminate the atomizing air proving switch from the circuitry.</p>
9. Atomizing Air Proving Switch: Dietz 162 P15	<p>Air pressure against the diaphragm actuates the switch which, when made, completes a circuit to prove the presence of atomizing air. Since the pressure of the atomizing air is at its minimum value when there is no fuel present at the nozzle, adjustment of the switch should be done while the unit is running but not firing. The control should be set to actuate under a condition of minimum pressure, but not too close to that point to cause nuisance shutdowns.</p> <p>The control adjustment may be made during the pre-purge period of operation by stopping the programmer during the pre-purge period through the use of the TEST switch. Refer to the control instruction bulletin for details.</p> <p>The adjustment screw of the atomizing air proving switch can then be adjusted until it breaks the circuit. At this point, the programmer will lockout and it must be manually reset before it can be restarted. Turn the adjusting screw up a half turn or so to remake the circuit.</p> <p>Since the adjustment of the air switch may be made either during the damper closed or open positions or pre-purge, it is also possible to make the adjustment with the relay stopped in the damper open position in a similar manner to the adjustment of the combustion air proving switch described in the previous section.</p> <p>After making the adjustment, recycle the control to be sure that normal operation is obtained. The TEST switch must be set to the RUN position.</p>

## 5.6 — Gas Pilot Flame Adjustment

The size of the gas pilot flame is regulated by adjusting the gas flow through the pilot gas regulator and the adjusting cock. The flame must be sufficient to ignite the main flame and to be seen by the flame detector but an extremely large flame is not required. An overly rich flame can cause sooting of the flame detector. Too small a flame can cause ignition problems.

Although it is possible to visibly adjust the size of the pilot flame, it is preferable to obtain a micro-amp reading of the flame signal.

The amplifier of the standardly used program relay has a meter jack for this purpose. This reading may be measured with a good quality micro-ammeter or a suitable multi-meter with a 0 to 25 micro-amp DC rating.

The meter is connected to the jack using a meter connecting plug harness (Cleaver-Brooks 884-72). Connect the plus (red meter lead) to the red tab of the harness and the minus (black meter lead) to the black tab before inserting the plug in the meter jack.

The program relay used may be of the type that provides message information that includes a constant flame signal of DC voltage. In this case a separate DC voltmeter is not required.

To measure and adjust the pilot:

1. When making a pilot adjustment, turn the manual-automatic switch to "manual" and the manual flame control to "close." Open both the pilot shutoff cock and the pilot adjusting cock. The main gas cock should remain closed.

The regulator in the pilot line, if provided, is to reduce the gas pressure to suit the pilot's requirement of between 5" to 10" W.C. Regulator adjustment is not critical, however, with a lower pressure the final adjustment of the pilot flame with adjusting cock is less sensitive.

2. Connect the micro-ammeter as outlined above.
3. Turn the burner switch on. Let the burner go through the normal pre-purge cycle. When the ignition trial period is signaled, set the test switch to the TEST position to stop the sequence.
4. If the pilot flame is not established within ten seconds, turn off the burner switch. Repeat the lighting attempt.

**NOTE:** On an initial starting attempt, portions of the fuel lines may be empty and require "bleeding" time. It is better to accomplish this with repeated short lighting trial periods with intervening purge periods than to risk prolonged fuel introduction. If the pilot does not light after several attempts, check all components of the pilot system.

5. When the pilot flame is established, and with the pilot adjusting cock wide open, remove the flame detector from the burner plate. The pilot flame can then be observed through this opening.

### Caution

Keep eyes sufficiently away from the sight tube opening and wear a protective shield or suitable safety glasses. Never remove the flame detector while the main burner is firing.

6. To make the final adjustment, slowly close the gas pilot adjusting cock until the flame can no longer be seen through the sight tube. Then slowly open the cock until a flame providing full sight tube coverage is observed.

This adjustment must be accomplished within the time limit of the safety switch or approximately 30 seconds after the detector is removed. If the control shuts down, manually reset it. Replace the detector and repeat from step 5.

7. When a suitable flame as indicated in step 6 is obtained, replace the detector. Observe the reading on the micro-ammeter. The reading should be between 2-1/4 and 5 micro-amperes when using a lead sulfide detector and a standard amplifier. See the flame signal table in the manufacturer's bulletin for values of other combinations.

The flame signal indicated on the annunciator type relay should not be less than 10 volts D.C. and may be as high as 20 or greater.

The reading must be steady. If the reading fluctuates, recheck the adjustment. Make sure that the flame detector is properly seated and that the lens is clean.

8. Return the test switch to the RUN position.
9. If main flame has not be previously established, proceed to do so in accordance with instructions provided elsewhere in the manual.
10. The reading of the main flame signal should also be checked. Observe the flame signal for pilot alone, pilot and main burner flame together, and the main burner flame at high, low, and intermediate firing rate position. Readings should be steady and in the range indicated in step 7. If there are any deviations, refer to the troubleshooting section in the technical bulletin.

## 5.7 — Gas Pressure and Flow Information

Because of variable in both the properties of gas and the supply system, it will be necessary to regulate the pressure of the gas to a level that produces a steady, dependable flame that yields highest combustion efficiency at rated performance yet prevents overfiring. Once this optimum pressure has been established, it should be recorded and periodic checks made to verify that the regulator is holding the pressure at this level. Occasional modification in fuel composition or pressure by the supplier may, at times, require readjustment to return the burner to peak efficiency. Since the gas pressure regulator itself is usually furnished by others, detailed adjustment instructions and adjusting procedures recommended by the manufacturer should be followed.

### 5.7.1 — Pressure

The gas supplied must provide not only the quantity of gas demanded by the unit, but must also be at a pressure high enough to overcome the pressure loss due to the frictional resistance imposed by the burner system and control valves.

The pressure required at the entrance to the burner train for rated boiler output is termed “net regulated pressure.” The gas pressure regulator must be adjusted to achieve this pressure to assure full input.

The pressure requirement varies with boiler size, altitude, and type of gas train. Refer to Table 1 for pressure requirements.

**TABLE 1. Minimum Net Regulated Gas Pressure for Rated Boiler Output (Required at Gas Train Entrance)**

<b>Boiler Size (H.P.)</b>	<b>Standard and FM Approved Train</b>	<b>IRI Approved Train</b>
50	4.5	5.5
60	5.5	6.5
70	8.0	9.5
80	9.5	11.0
100	8.5	10.5
100A	8.5	10.5
100S	9.0	11.5
125A	12.0	12.0

The pressures listed are based on 1000 BTU/cu. ft. natural gas at elevations up to 700 feet above sea level. For installation at higher altitudes, multiply the selected pressure by the proper factor from Table 2.

**TABLE 2. Higher Altitude Installation Factors**

Altitude: Feet Above Sea Level	Correction Factor
1000	1.04
2000	1.13
2500	1.18
3000	1.22
4000	1.33
5000	1.44
6000	1.57
7000	1.70
8000	1.84
9000	2.01

### 5.7.2 — Gas Flow

The volume of gas flow is measured in terms of cubic feet and is determined by a meter reading. The gas flow rate required for maximum boiler output depends on the heating value (BTU/cu. ft.) of the gas supplied. The supplying utility can provide this information.

To obtain the required number of cubic feet per hour of gas, divide the heating value (BTU/cu. ft.) into the required burner input (BTU/hr.). See Table 3 for input requirements.

**TABLE 3. Input Requirements**

Boiler Horsepower	Maximum Input: BTU/hr.
50	2,092,000
60	2,511,000
70	2,929,000
80	3,347,000
100	4,184,000
125A	5,230,000

### 5.7.3 — Pressure Correction

The flow rate outlined in the previous section is figured on a “base” pressure which is usually atmospheric or 14.7 psi.

Meters generally measure gas in cubic feet at “line” or supply pressure. The pressure at which each cubic foot is measured and the correction factor for this pressure must be known in order to convert the quantity indicated by the meter into the quantity which would be measured at “base” pressure.

To express the volume obtained from an actual meter reading into cubic feet at base pressure, it is necessary to multiply the meter index reading by the proper pressure factor obtained from Table 4.

**TABLE 4. Pressure Correction Factors**

Regulator Inlet Pressure	Pressure Factor	Regulator Inlet Pressure	Pressure Factor
1 psig	1.05	9 psig	1.59
2 psig	1.11	10 psig	1.66
3 psig	1.18	11 psig	1.72
4 psig	1.25	12 psig	1.81
5 psig	1.32	13 psig	1.86
6 psig	1.39	14 psig	1.93
7 psig	1.45	15 psig	2.00
8 psig	1.52		

**Conversely:** To determine what the meter index reading should be in order to provide the volume of gas required for input, divide the desired flow rate by the proper pressure correction factor. This answer indicates the number of cubic feet at line pressure which must pass through the meter to deliver the equivalent number of cubic feet at base pressure.

For example, assume:

- that a 100 horsepower boiler is installed at 2,000 feet above sea level
- is equipped with a standard gas train
- that 1,000 BTU natural gas is available with an incoming gas pressure of 3 psig

The pressure and flow can be determined as follows:

**Pressure:** Correction for the 2,000 feet altitude must be made since altitude has a bearing on the net regulated gas pressure. The standard gas train requires 8.5" W.C. gas pressure at sea level. Table 2 indicates a correction factor of 1.07 for 2,000 feet. Multiplying these results in a calculated net regulated gas requirement of approximately 9.1" W.C. This is the initial pressure to which the regulator should be adjusted. Slight additional adjustment can be made later, if necessary, to obtain the gas input needed for burner rating.

**Flow:** Since the gas flow rate is based on standard conditions of flow, correction must be made for the supply pressure through the meter of 3 psig. Determine the flow rate by dividing the BTU content of the gas into the burner input (Table 3) and "correct this answer by applying the correction factor for 3 psig (Table 4).

$$\frac{\text{BTU/hr Input}}{\text{BTU/cu. ft.}} = \text{CFH (Cubic Feet/Hour)}$$

OR

$$\frac{4,184,000}{1,000} = 4,184 \text{ CFH (at 14.7 lb. atmospheric "base" pressure)}$$

THEN

$$\frac{4,184}{1.18} = 3,546 \text{ CFH}$$

This is the CFH (at line pressure) which must pass through the meter so that the equivalent full input requirement of 4,184 CFH (at base pressure) will be delivered.

**Checking Gas Flow:** Your gas supplier can generally furnish a gas meter flow chart from which gas flow can be determined. After a short observation period, this information aids in adjusting the regulator to increase or decrease flow as required to obtain rating.

Final adjustment of gas fuel is carried out by means of the adjusting screws in the gas modulating cam while performing a combustion efficiency analysis. See Section 5.8 for details.

**NOTE:** The information given in this section is for all practical purposes sufficient to set and adjust controls for gas input. Your gas supplier can, if necessary, furnish exact correction factors that take into consideration BTU content, exact base pressure, specific gravity, temperature, etc., of the gas used.

## 5.8 — Gas Fuel Combustion Adjustment

After operating for a sufficient period of time to assure a warm boiler, adjustments should be made to obtain efficient combustion.

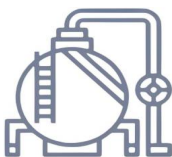
The appearance or color of the gas flame is not an indication of its efficiency since an efficient gas flame will vary from transparent blue to translucent yellow.

Proper setting of the air/fuel ratios at all rates of firing must be established by the use of a combustion gas analyzer. This instrument measures the content, by percentage, of carbon dioxide (CO<sub>2</sub>), oxygen (O<sub>2</sub>), and carbon monoxide (CO) in the flue gas.

Burner efficiency is measured by the amount or percentage of CO<sub>2</sub> present in the flue gas. The theoretical maximum CO<sub>2</sub> percentage for natural gas is approximately 11.7%. As shown in Figure 5-5, this is attained when there is no excess oxygen (O<sub>2</sub>) or carbon monoxide (CO). A definite percentage of excess air (oxygen) is required by most local authorities and the burner should never be operated with an air-fuel ratio that indicates a detectable percentage of carbon monoxide.

Subject to local regulations pertaining to specific amounts of excess oxygen, it is generally recommended that CO<sub>2</sub> readings of between 9-1/2% and 10-1/2% be attained with corresponding O<sub>2</sub> readings of 2% to 4%.

From information in Section 5.7 of this chapter, determine the standard condition of gas pressure and flow for the size of the boiler and its gas train. Calculate the actual pressure and flow through the use of correction factors that compensate for incoming gas pressure and altitude.



Courtesy of: **C3 Surplus LLC**  
**Surplus Industrial Superstore**  
**305-428-2777**  
**<https://www.c3surplus.com>**

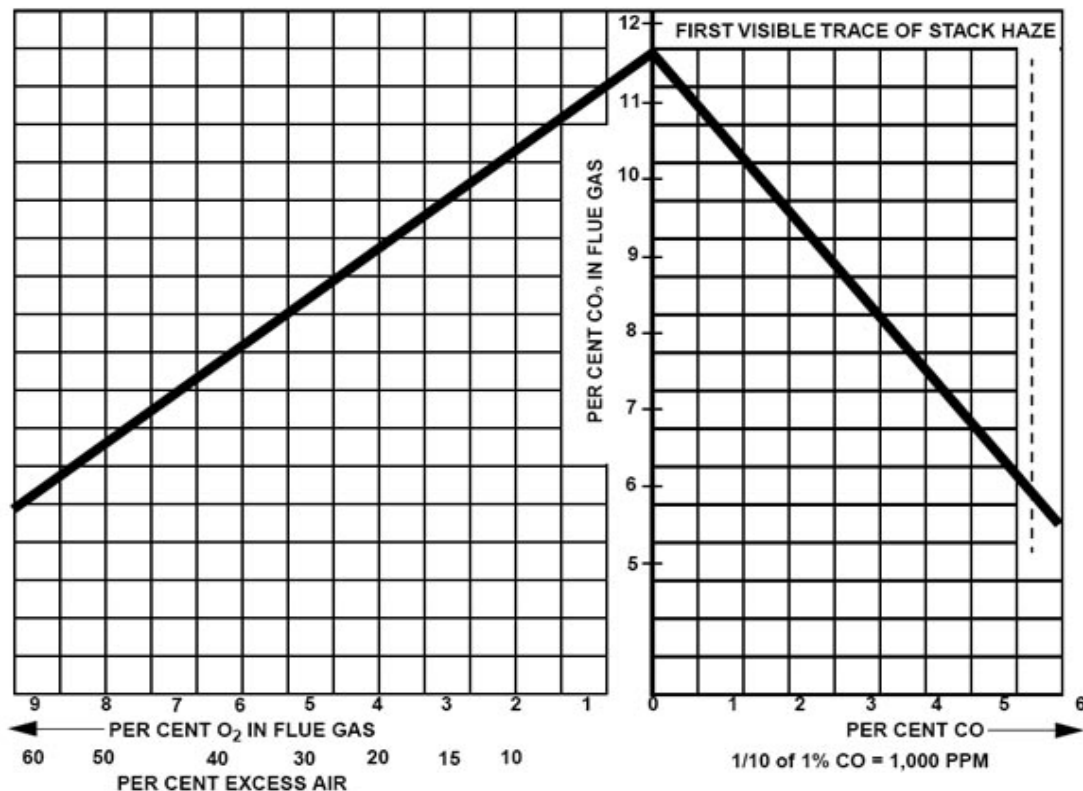


FIGURE 5-5. Flue Gas Analysis Chart for Natural Gas

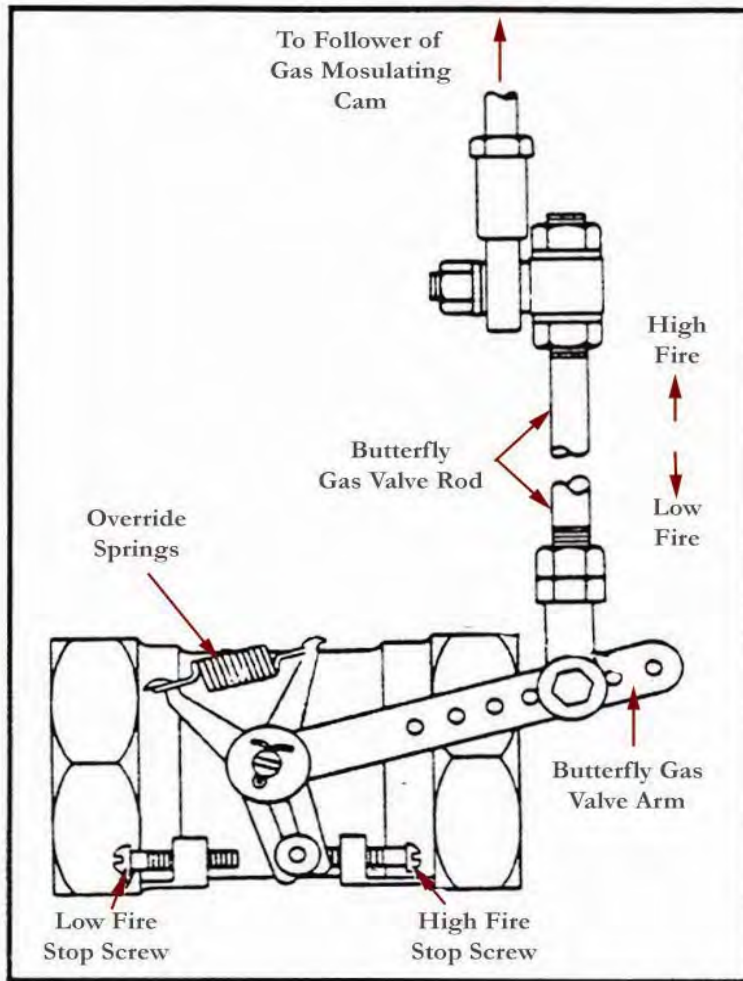
Basically, gas adjustments are made with a gas pressure regulator which controls the pressure and with the butterfly gas valve which directly controls the rate of flow.

In initially setting the linkage, back off the low fire stop screw on the butterfly valve so that the valve is closed. Then run the screw out to touch the arm and give it two complete turns. Adjust the connecting rod so that override tension is released and so that the arm is now just touching the stop screw. Tighten the lock nuts on all ball joints.

This low fire setting should be regarded as tentative until proper gas pressure for high fire operation is established.

To do this, turn the manual flame control switch to "high." At high fire position the butterfly valve should be wide open as indicated by the slot on the end of its shaft. Set and lock the high fire stop screw until it is just touching the valve arm.

Determine the actual gas flow from a meter reading. See Section 5.7. With the butterfly valve open and with regulated gas pressure set at the calculated pressure, the actual flow rate should be quite close to the required input. If corrections are necessary, increase or decrease the gas pressure by adjusting the gas pressure regulator, following manufacturer's directions for regulator adjustment.



**FIGURE 5-6. Butterfly Gas Valve**

When proper gas flow is obtained, take a flue gas analysis reading the CO<sub>2</sub> should be between 9-1/2% and 10-1/2% and the corresponding O<sub>2</sub> reading should be 2% to 4%.

With the high fire air-fuel ratio established, the gas pressure regulator needs no further adjusting.

After making certain that the air control damper and its linkage are correctly adjusted to provide the proper amount of secondary air and after adjusting the gas pressure regulator, final adjustment can be made, if necessary, to the gas modulating cam to obtain a constant air-fuel ratio throughout the entire firing range.

Since the input of combustion air is ordinarily fixed at any given point in the modulating cycle, the flue gas reading is determined by varying the input of gas fuel at that setting. This adjustment is made to the metering cam by means of adjusting screws which are turned out (counterclockwise from the hex-socket end) to increase the flow of fuel, and in (clockwise from the hex-socket end) to decrease it. Flow rate is highest when the cam follower assembly is closest to the jackshaft.



Through the manual flame control switch, position the cam so that the adjusting screw adjacent to the end or high fire screw contacts the cam follower. Make a combustion analysis at this point. If an adjustment is necessary, turn the adjustment screw accordingly to increase or decrease fuel flow. Take a combustion reading to verify input. Repeat as necessary until the desired flow is obtained.

**NOTE:** Do not use any lubricant on the adjusting setscrews. These have a nylon locking insert intended to provide locking torque and resistance to loosening.

Repeat this process, stopping at each adjusting screw until low fire position is reached. If all screws are properly adjusted, none will deviate from the general overall contour of the cam face. It may be necessary to readjust the setting of the low fire stop screw in order to obtain proper air fuel ratio at low fire burning rate. To insure that the low fire position of the butterfly valve is always the same, allow one turn of the stop screw for over-travel.

---

## 5.9 — Low Gas Pressure Switch

Adjust the scale setting to slightly below the normal burning pressure. The control circuit will be broken when pressure falls below this point. Since gas line distribution pressure may decrease under some conditions, shutdowns may result if the setting is too close to normal. However, regulations require that the setting may not be less than 50% of the rated pressure downstream of the regulator.

Manual resetting is necessary after a pressure drop. Press the reset lever after pressure is restored. Make sure that a mercury switch equipped control is level.

---

## 5.10 — High Gas Pressure Switch

Adjust the scale setting to slightly above the normal burning pressure. The control circuit will be broken when pressure exceeds this point. Unnecessary shutdowns may result if the setting is too close to normal, however, regulations require that the setting may not be greater than 50% of the rated pressure.

Manual resetting is necessary after a pressure rise. Press the reset lever after pressure falls. Make sure that a mercury switch equipped control is level.

---

## 5.11 — Fuel Oil Pressure and Temperature: General

Variations in burning characteristics of the fuel oil may require adjustments from time to time to assure highest combustion efficiency. The handling and burning characteristics may vary from one delivery of oil to another. For this reason it is recommended that the oil system be inspected from time to time to verify that pressures and viscosity are at the proper operating levels.

Because of variation in oils including chemical content, source, blends, and viscosity characteristics, the temperatures and pressures listed in Chapter 4 and mentioned in the adjusting of the controls in the following paragraphs will vary and thus may be regarded as tentative and to be changed to provide best firing conditions. The Oil Viscosity Chart (Figure 5-7) may be used as a guide, although your oil supplier will be able to give you more exacting information based on an analysis of the oil.

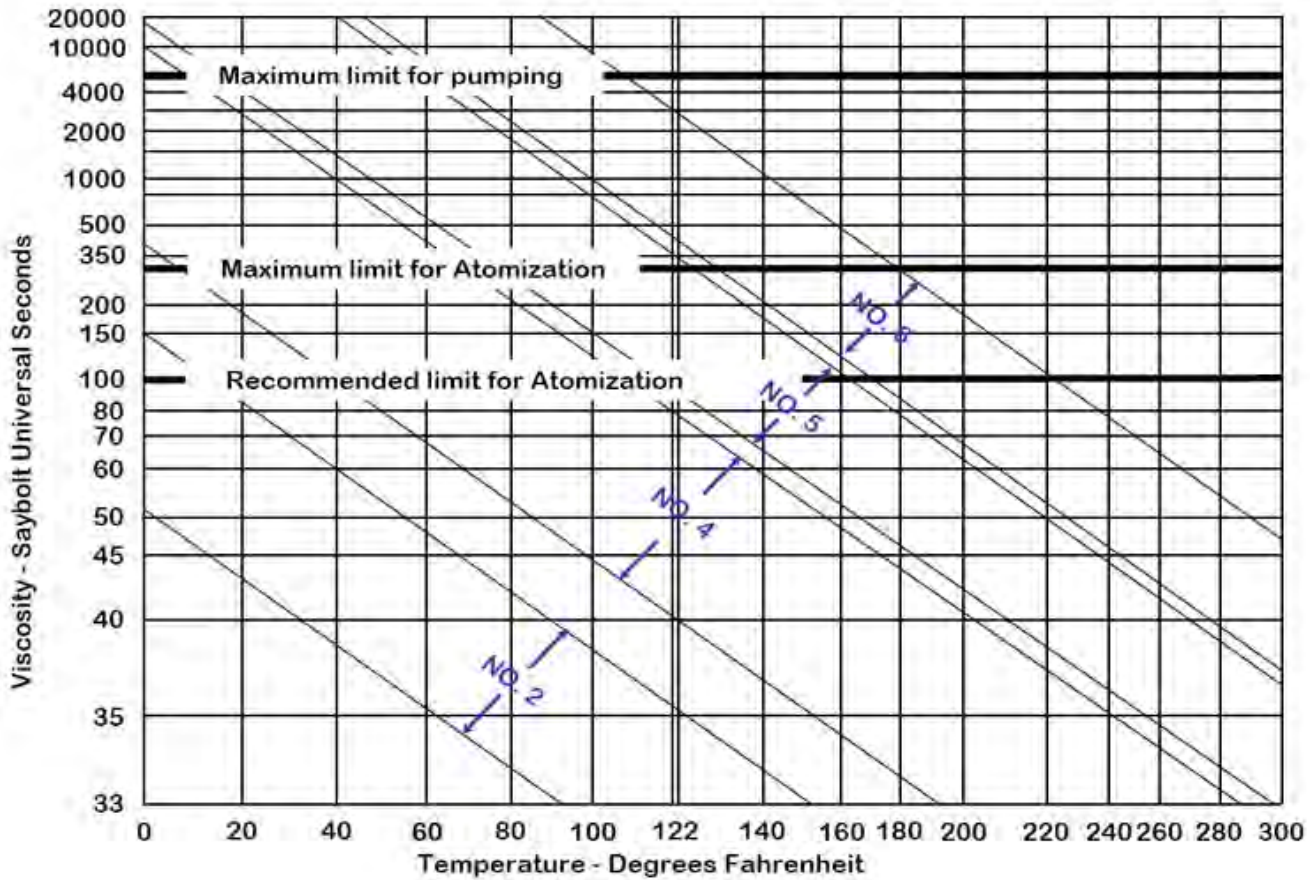


FIGURE 5-7. Oil Viscosity Chart

Review of the applicable maintenance instructions given in Chapter 7 will aid in maintaining an efficient fuel system.

**NOTE:** To prevent oil heater coking, the fuel oil pump must be in operation during all times that an oil heater is in service. During any time that the oil pump is not operating, the oil heating system must be electrically shut down by manually turning the oil heater switch to “off.”

When the boiler is shut down, or switched over to gas firing, the pump must operate for a sufficient period of time to cool the oil heater. Similarly, if an electric, steam, or hot water oil heater is removed for servicing, the temperature of the heater should be reduced by circulating oil until it is.

## 5.12 — Fuel Oil Combustion Adjustment

After operating for a sufficient period of time to assure a warm boiler, adjustments should be made to obtain efficient combustion.

Efficient combustion cannot be solely judged by flame condition or color, although they may be used in making approximate settings. This should be done so that there is a bright sharp flame with no visible haze.

Proper setting of the air-fuel ratios, at all rates of firing must be established by the use of a combustion gas analyzer. This instrument measures the content, by percentage, of carbon dioxide (CO<sub>2</sub>), oxygen (O<sub>2</sub>), and carbon monoxide (CO) in the flue gas.

Burner efficiency is measured by the amount of percent of CO<sub>2</sub> present in the flue gas. The ideal setting from a standpoint of efficiency is reached when the percentage of oxygen in the flue gas is zero. It is, however, more practical to set the burner to operate with a reasonable amount of excess air to compensate for minor variations in the pressure, temperature, or burning properties of oil. 15% to 20% excess air is considered reasonable and this should result in an approximate CO<sub>2</sub> reading of 12-1/2% to 13%.

The burner should never be operated with an air-fuel ratio that indicates a detectable percentage of carbon monoxide.

Through the use of the manual flame control slowly bring the unit to high fire by stages. At the high fire position the air damper should be fully opened and the air and oil pressure readings should be on the order of those given in Chapter 4.

Take a flue gas analysis reading at this point. If necessary, make adjustments to the fuel oil controller to increase or decrease oil pressure. This should be done before making any effort to adjust the screws in the metering cam. Ideally, the cam profile spring should be as close to the cam casting as practical and it is more desirable to lower the oil pressure to reduce flow, if necessary, than to extend adjusting screws to an extreme position in an effort to cut back on flow.

After making certain that the air control damper and its linkage are operating properly to provide the proper amount of secondary air and that fuel oil pressure settings are correct, final adjustment can be made, if necessary, to the oil modulating cam to obtain a constant fuel-air ratio through the entire firing range.

Since the input of combustion air is ordinarily fixed at any given point in the modulating cycle, the flue gas reading is determined by varying the input of fuel at that setting. This adjustment is made to the metering cam by means of adjusting screws, which are turned out (counterclockwise from hex-socket end) to increase the flow of fuel and in (clockwise from hex-socket end) to decrease it. Flow rate is highest when the cam follower assembly is closest to the jackshaft.

If oil pressure, primary air pressure, and linkages are properly adjusted, the metering cam should require minimal adjustment.

If adjustment is necessary, follow this recommended procedure:

1. Through the flame control switch, position the cam so that the adjusting screw adjacent to the end or high fire screw contacts the cam follower. Make a combustion analysis at this point.
2. If an adjustment is necessary, turn the adjustment screw accordingly to increase or decrease fuel flow. Take a combustion reading to verify input.
3. Repeat as necessary until the desired flow is obtained.

**NOTE:** Do not use any lubricant on the adjusting setscrews. These have a nylon locking insert intended to provide locking torque and resistance to loosening.

- Repeat this process, stopping at each adjusting screw until low fire position is reached. If all screws are properly adjusted, none will deviate from the general overall contour of the cam face.

### 5.13 — Burner Drawer Adjustment

There are relatively few adjustments that can be made to the burner, however, a check should be made to see that all components are properly located and that all holding screws are properly tightened.

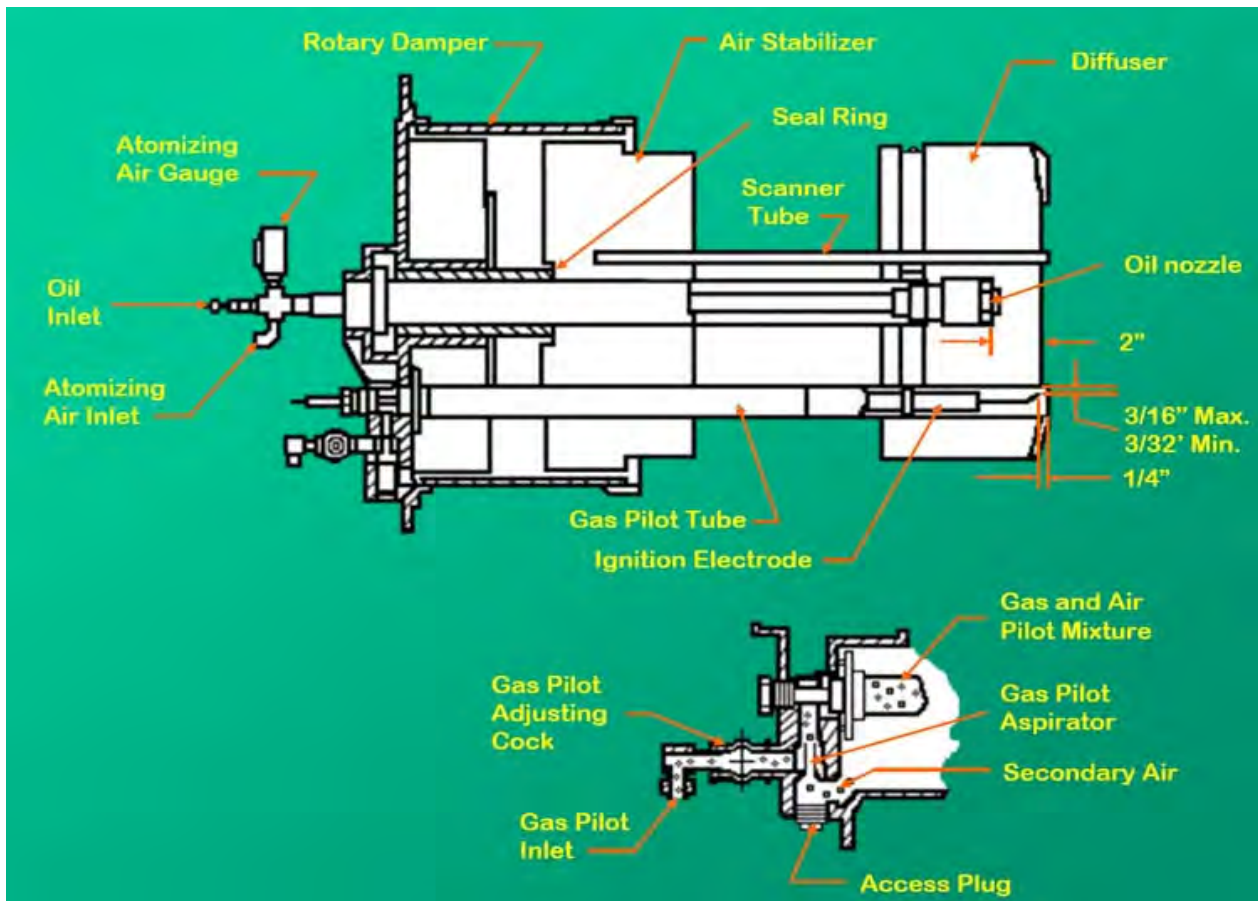
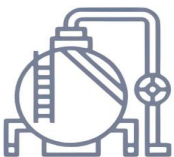


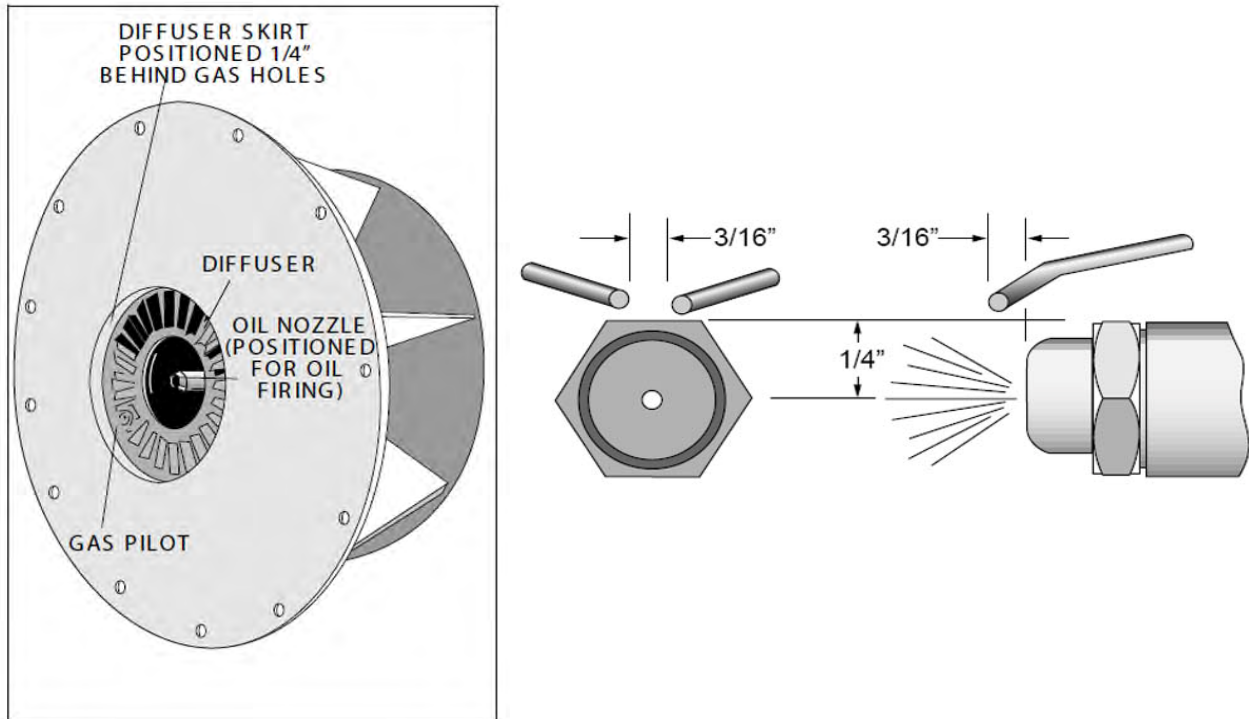
FIGURE 5-8. Burner Drawer with Gas Pilot

The diffuser location on gas fired boilers is quite important. There should be 1/4" distance between the inside edge of the gas exit holes in the burner tube and the skirt of the diffuser. The setting of an oil fired burner is less exacting and the diffuser should be located with skirt approximately 1" from the end of the burner tube.

Check the location of the nozzle after the diffuser setting is verified. CB50 through CB80 boilers have a perforated plate attached to the spider and the nozzle should protrude 1/8" beyond this plate. Locate the nozzle approximately 3/8" behind the diffuser on CB100, CB100A, and CB125A boilers.



Courtesy of: **C3 Surplus LLC**  
**Surplus Industrial Superstore**  
 305-428-2777  
<https://www.c3surplus.com>



**FIGURE 5-9. Diffuser and Oil Pilot Electrode**

Readjust the gun locking plate, if required to obtain these settings. It is important that the oil spray does not impinge upon the diffuser. Check the nozzle for wear and replace, if necessary, before deviating from the recommended setting.

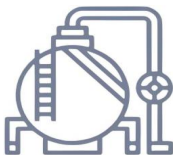
Check the setting of the ignition electrode(s) for proper gap and position. Make sure that the porcelain insulator is not cracked and that ignition cable connections are tight.

The oil nozzle tip should be seated tightly in the body with the swirler and the seating spring in place. See Chapter 7, Section 7.7 for additional nozzle tip information.

Check to see that the flame detector sight tube and the gas pilot tube extend through their respective openings in the diffuser face.

## 5.14 — Oil Drawer Switch

The integral contacts of this control are closed by proper positioning and latching of the oil drawer in its forward position. Adjustment of the switch must be such that its contacts open if the oil drawer is not properly positioned for oil firing. The switch is electrically removed from the circuit when a combination fuel burner is fired on gas.



Courtesy of: **C3 Surplus LLC**  
**Surplus Industrial Superstore**  
**305-428-2777**  
<https://www.c3surplus.com>

---

### 5.15 — Low Oil Temperature Switch

This control prevents the burner from starting, or stops its operation, if the temperature of the oil is below normal operating temperature.

To adjust the control on a No. 6 oil fired steam boiler, insert a screwdriver into the center slot in the control cover and turn the dial until the fixed (center) pointer is approximately 30° F lower than the oil heater thermostat setting. Turn the differential adjusting screw (located above the dial) until the movable indicator is approximately 5° F above the setting on the main scale.

On a standardly equipped No. 5 oil burner, and on a No. 6 oil burner installed on a hot water boiler, the low oil temperature switch is an integral part of the electric oil heater. The switch in this case is non-adjustable and is factory set at approximately 40° F below the maximum operating temperature of the heater.

---

### 5.16 — High Oil Temperature Switch (Optional)

This control prevents the burner from starting, or stops its operation, if the temperature of the oil exceeds the normal operating temperature.

To adjust, turn the dial until the pointer is approximately 25° F above normal operating temperature. These controls generally have a set differential and will close 5° F below the set point.

---

### 5.17 — Low Oil Pressure Switch (Optional)

This control prevents burner ignition, or stops its operation, when the oil pressure is below a set point. Adjust the control by turning the screw on top of the control case to an indicated pressure 10 psi below the established primary oil pressure setting indicated on the oil supply pressure gauge. The switch will remain in a closed position as long as the oil pressure exceeds this setting. The control normally used automatically resets when pressure is restored after a drop.

---

### 5.18 — Electric Oil Heater Thermostat: Steam, Series 400, 600

The maximum temperature setting of the control is stamped on the dial. This is attained with the adjusting knob turned to the “high” end of the scale. Lower settings are obtained by turning the adjusting knob clockwise using the thermometer in the fuel oil controller as a guide.

The final setting of this thermostat should be at a sufficiently lower temperature (approximately 15°) than the steam heater thermostat. This eliminates the electric heater from operation when the steam heater is functioning. The electric heater is sized to provide sufficient heated oil for low fire operation on cold starts before steam is available.

A 0.005 MFD capacitor is wired in parallel with the thermostat lead connections to prevent contact bounce and arcing. The control differential is non-adjustable.

---

## 5.19 — Oil Heater Thermostat: Series 300, 500, 800, 900

The electric oil heater on a No. 4 or No. 5 oil fired burner has a built-in adjustable thermostat. The maximum temperature setting is stamped on its dial. Desired temperature can be obtained by turning the adjusting screw using the thermometer in the fuel oil controller as a guide.

A hot water burner burning No. 6 oil and equipped with a hot water oil heater also uses this type of electric heater and thermostat. In this case, the thermostat should be set at a sufficiently lower temperature (approximately 15°) than the hot water heater thermostat. This eliminates the electric heater from operation when the water heater is functioning. The electric heater is sized to provide sufficient heated oil for low fire operation on cold starts before hot water is available.

---

## 5.20 — Steam Oil Heater Thermostat: Steam, No. 6 Oil, Series 400, 600

The maximum temperature setting of the control is stamped on the dial. This is attained with the adjusting knob turned to the “high” end of the scale. Lower settings are obtained by turning the adjusting knob clockwise using the thermometer in the fuel oil controller as a guide.

The final setting of this thermostat should provide oil at a sufficient temperature for efficient combustion based on flue gas analysis. There is no need to heat the oil in excess of this temperature.

A 0.005 MFD capacitor is wired in parallel with the thermostat lead connections to prevent contact bounce and arcing. The control differential is non-adjustable.

---

## 5.21 — Hot Water Oil Heater Thermostat: Series 400, 600

To adjust, insert a screwdriver into the center slot in the control cover and turn the dial until the pointer is at the desired temperature level. This control generally has a set differential and will close 5° F below the set point.

The thermostat contacts close to energize the booster water pump which pumps water from the boiler through the heater. On cold starts it is normal practice to manually close the valve in the pump discharge line until boiler water temperature exceeds the temperature of fuel oil entering the heater.

The electric oil heater on a hot water boiler burning No. 6 oil and equipped with a hot water oil heater has a built-in adjustable thermostat. The maximum temperature setting is stamped on its dial. Desired temperature can be obtained by turning the adjusting screw. The thermostat should be set at a sufficiently lower temperature (approximately 15°) than the hot water heater thermostat. This eliminates the electric heater from operation when the water heater is functioning. The electric heater is sized to provide sufficient heated oil for low fire operation on cold starts before hot water is available.

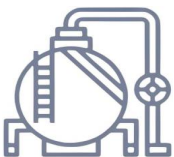
---

## 5.22 — Steam Heater Pressure Regulator: Steam, Series 400, 600

This regulator is provided on a boiler designed to operate at pressures above 15 psi for the purpose of reducing boiler steam pressure to the level necessary for proper operation of the steam oil heater. This pressure should be

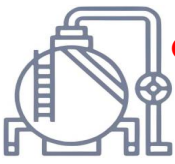
reduced to a point that permits sufficient temperature to heat the oil while allowing as continuous a steam flow as possible. Reduced pressure that is too high will result in frequent cycling of the steam solenoid valve.

It is best to adjust the regulator under typical flow conditions. To do this it is suggested that the glove valve in the steam supply line be closed so that there is no pressure on the regulator. Turn out the adjusting screw fully to relieve compression on the regulator spring thus closing the regulator. With steam at normal pressure, open the globe valve and then set the secondary pressure by turning the adjusting screw or handle until the downstream gauge shows the desired pressure.



**Courtesy of: C3 Surplus LLC**  
**Surplus Industrial Superstore**  
**305-428-2777**  
**<https://www.c3surplus.com>**





## 6.1 — Overview

 **Warning**

Troubleshooting should be performed only by personnel who are familiar with the equipment and who have read and understand the contents of this manual. Failure to follow these instructions could result in serious injury or death.

 **Warning**

Disconnect and lock out the main power supply in order to avoid the hazard of electrical shock. Failure to follow these instructions could result in serious injury or death.

**NOTE:** The make or model of the program relay provided will vary depending upon job specifications. The following sequence applies regardless of the make or model. Please refer to the Wiring Diagram (WD) prepared by Cleaver-Brooks for your specific installation.

This chapter assumes that the unit has been properly installed and adjusted, and that it has been running for some time. It is further assumed that the operator has become thoroughly familiar with both burner and manual by this time. The points under each heading are set down briefly as possible causes, suggestions, or clues to simplify locating the source of trouble. Methods of correcting the trouble, once it has been identified, may be found elsewhere in this manual.

If the burner will not start or operate properly, this troubleshooting section and the technical bulletin should be referred to for assistance in pinpointing problems that may not be readily apparent.

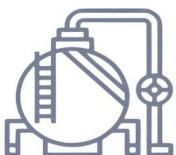
The program relay has the capability to self-diagnose and to display a code or message that indicates the failure condition. Refer to the control bulletin for specifics and suggested remedies.

Familiarity with the programmer and other controls in the system may be obtained by studying the contents of this manual and the bulletin. Knowledge of the system and its controls will make troubleshooting much easier.

Costly downtime or delays can be prevented by systematic checks of the actual operation against the normal sequence to determine the stage at which performance deviates from normal. Following a routine may possibly eliminate overlooking an obvious condition, often one that is relatively simple to correct.

If an obvious condition is not apparent, check the continuity of the circuits with a voltmeter or test lamp. Each circuit can be checked and the fault isolated and corrected. Most circuitry checking can be done between appropriate terminals on the terminal boards in the control cabinet or the entrance box. Refer to the schematic wiring diagram for terminal identification.

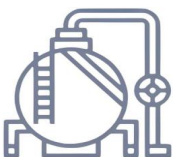
Problem	Possible Cause(s)
BURNER DOES NOT START	1. No voltage at program relay power input terminals. A. Main disconnect switch open. B. Blown control circuit fuse. C. Loose or broken electrical connection.
	2. Program relay safety switch requires resetting.
	3. Limit circuit not completed - no voltage at end of limit circuit program relay terminal. A. Pressure or temperature is above setting of operation control. (Load demand light will not glow.) B. Water below required level. 1) Low-water light (and alarm horn) should indicate this condition. 2) Check manual reset button (if provided) on low-water control. C. Fuel pressure must be within settings of low pressure and high pressure switches. D. Oil fired unit - burner gun must be in full forward position to close oil drawer switch. E. Heavy oil fired unit - oil temperature below minimum settings.
	4. Fuel valve interlock circuit not completed. A. Fuel valve auxiliary switch not enclosed.



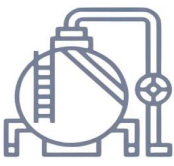
Courtesy of: **C3 Surplus LLC**  
**Surplus Industrial Superstore**  
**305-428-2777**  
<https://www.c3surplus.com>

<b>Problem</b>	<b>Possible Cause(s)</b>
NO IGNITION	1. Lack of spark. A. Electrode grounded or porcelain cracked. B. Improper electrode setting. C. Loose terminal on ignition cable - or cable shorted. D. Inoperative ignition transformer. E. Insufficient or no voltage at pilot ignition circuit terminal.
	2. Spark but no flame. A. lack of fuel - no gas pressure, closed valve, empty tank, broken line, etc. B. Inoperative pilot solenoid. C. Insufficient or no voltage at pilot ignition circuit terminal. D. Too much air.
	3. Low-fire switch open in low-fire proving circuit. A. Damper motor not closed, slipped cam, defective switch. B. Damper jammed or linkage binding.
	4. Running interlock circuit not completed. A. Combustion or atomizing air proving switches defective or not properly set. B. Motor starter interlock contact not closed.
	5. Flame detector defective, sight tube obstructed, or lens dirty.
PILOT FLAME, BUT NO MAIN FLAMW	1. Insufficient pilot flame.
	2. Gas fired unit: A. Manual gas cock closed. B. Main gas valve inoperative. C. Gas pressure regulator inoperative.
	3. Oil fired unit: A. Oil supply cut off by obstruction, closed valve, or loss of suction. B. Supply pump inoperative. C. No fuel. D. Main oil valve inoperative. E. Check oil nozzle, gun, and lines.
	4. Flame detector defective, sight tube obstructed or lens dirty.
	5. Insufficient or no voltage at main fuel valve circuit terminal.
BURNER STAYS IN LOW-FIRE	1. Pressure or temperature above modulating control setting.
	2. Manual-automatic switch in wrong position.
	3. Inoperative modulating motor.
	4. Defective modulating control.
	5. Binding or loose linkage, cams, setscrews, etc.

Problem	Possible Cause(s)
SHUTDOWN OCCURS DURING FIRING	1. Loss or stoppage of fuel supply.
	2. Defective fuel valve, loose electrical connection.
	3. Flame detector weak or defective.
	4. Lens dirty or sight tube obstructed.
	5. If the programmer lockout switch has not tripped, check the limit circuit for an opened safety control.
	6. If the programmer lockout switch has tripped: A. Check fuel lines and valves. B. Check flame detector. C. Check for open circuit in running interlock circuit. D. The flame failure light is energized by ignition failure, main flame failure, inadequate flame signal, or open control in the running interlock circuit.
	7. Improper air/fuel ratio (lean fire): A. Slipping linkage. B. Damper stuck open. C. Fluctuating fuel supply: 1) Temporary obstruction in fuel line. 2) Temporary drop in gas pressure. 3) Orifice gate valve open.
	8. Interlock device inoperative or defective.
MODULATING MOTOR DOES NOT OPERATE	1. Manual-automatic switch in wrong position.
	2. Linkage loose or jammed.
	3. Motor does not drive to open or close during pre-purge or close on burner shutdown: A. Motor defective. B. Loose electrical connection. C. Damper motor transformer defective.
	4. Motor does not operate on demand: A. Manual-automatic switch in wrong position. B. Modulating control improperly set or inoperative. C. Motor defective. D. Loose electrical connection. E. Damper motor transformer defective.



Courtesy of: **C3 Surplus LLC**  
**Surplus Industrial Superstore**  
**305-428-2777**  
<https://www.c3surplus.com>



---

## 7.1 — Overview

A well planned maintenance program avoids unnecessary downtime or costly repairs, promotes safety, and aids boiler code and local inspectors. An inspection schedule with a listing of procedures should be established. It is recommended that a boiler room log or record be maintained. Recording of daily, weekly, monthly, and yearly maintenance activities provides a valuable guide and aids in obtaining economical and lengthy service from Cleaver-Brooks equipment.

Even though the boiler has electrical and mechanical devices that make it automatic or semi-automatic in operation, these devices require systematic and periodic maintenance. Any “automatic” feature does not relieve the operator from responsibility, but rather frees him of certain repetitive chores providing him time to devote to upkeep and maintenance.

Good housekeeping helps maintain a professional appearing boiler room. Only trained and authorized personnel should be permitted to operate, adjust, or repair the boiler and its related equipment. The boiler room should be kept free of all material and equipment not necessary to the operation of the boiler or heating system.

Alertness in recognizing an unusual noise, improper gauge reading, leaks, etc., can make the operator aware of a developing malfunction permitting prompt corrective action that may prevent extensive repairs or unexpected downtime. Any leaks — fuel, water, steam, exhaust gas — should be repaired promptly and under conditions that observe necessary safety precautions. Include in the program preventive maintenance measures such as regularly checking the tightness of connections, locknuts, setscrews, packing glands, etc.

The air-fuel ratio should be checked often since this will alert the operator to losses in combustion efficiency which do not produce visible flame change. Variations in fuel composition from one time to another may require readjustment of the burner. A combustion analyzer should be used to adjust fuel input for maximum operating efficiency and economy.

### 7.1.1 — Periodic Inspection

Insurance regulations or local laws require a periodic inspection of the pressure vessel by an authorized inspector.

Section 2.1 in Chapter 2 contains information relative to this inspection.

Inspections of this type are usually, though not necessarily, scheduled for periods of normal boiler downtime such as an off season. This major inspection can often be used to accomplish maintenance, replacement, or repairs that cannot easily be done at other times. This also serves as a good basis for establishing a schedule for annual, monthly, or other periodic maintenance program.

While this inspection pertains primarily to the waterside and fireside surfaces of the pressure vessel, it provides the operator an excellent opportunity for detailed inspection and check of all components of the boiler including piping, valves, pumps, gaskets, refractory, etc. Comprehensive cleaning, spot painting or repainting, and the replacement of expendable items should be planned for and taken care of during this time. Any major repairs or replacements that may be required should also, if possible, be coordinated with this period of boiler shutdown.

Replacement spare parts, if not on hand, should be ordered sufficiently prior to shutdown.

Cleaver-Brooks boilers are designed, engineered and built to give long life and excellent service on the job. Good operating practices and conscientious maintenance and care will obtain efficiency and economy from their operation and contribute to many years of performance.

---

## 7.2 — Fireside Cleaning

Soot and non-combustibles are effective insulators and if allowed to accumulate will reduce heat transfer to the water and increase fuel consumption. Soot and other deposits can be very moisture absorbent and may attract moisture to form corrosive acids which will deteriorate fireside metal.

Clean-out should be performed at regular frequent intervals depending upon load, type and quality of fuel, internal boiler temperature, and combustion efficiency. A stack temperature thermometer, if used, can be a guide to clean-out intervals since an accumulation of soot deposits will raise the flue gas temperature.

Tube cleaning is accomplished by opening front and rear doors. Tubes may be brushed from either end. All loose soot and accumulations should be removed. Any soot or other deposits should be removed from the furnace and the tube sheets.

Refer to Section 7.17 of this chapter for instructions on properly closing front and rear heads.

The vent stub and stack should be cleaned at regular intervals. Commercial firms are available to perform this work. The stack should be inspected for damage and repaired as required.

The fireside should be thoroughly cleaned prior to any extended lay-up of the boiler. Depending upon circumstances, a protective coating may be required.

---

## 7.3 — Water Level Controls and Waterside of Pressure Vessel

The need to periodically check water level controls and the waterside of the pressure vessel cannot be over-emphasized. Most instances of major boiler damage are the result of operating with low water or the use of untreated or incorrectly treated water.

Always be sure of the boiler water level. The water column should be blown down routinely. Check samples of the boiler water and condensate in accordance with procedures recommended by your water consultant. Refer to Sections 2.8 And 2.9 in Chapter 2 for blowdown instructions and internal inspection procedures.

Since low water cut-off devices are generally set by the original manufacturer, no attempt should be made to adjust these controls to alter the point of low water cut-off or point of pump cut-in or cut-out. If a low water device should become erratic in operation, or if its setting changes from previously established levels, check for reasons and correct, repair or replace as required.

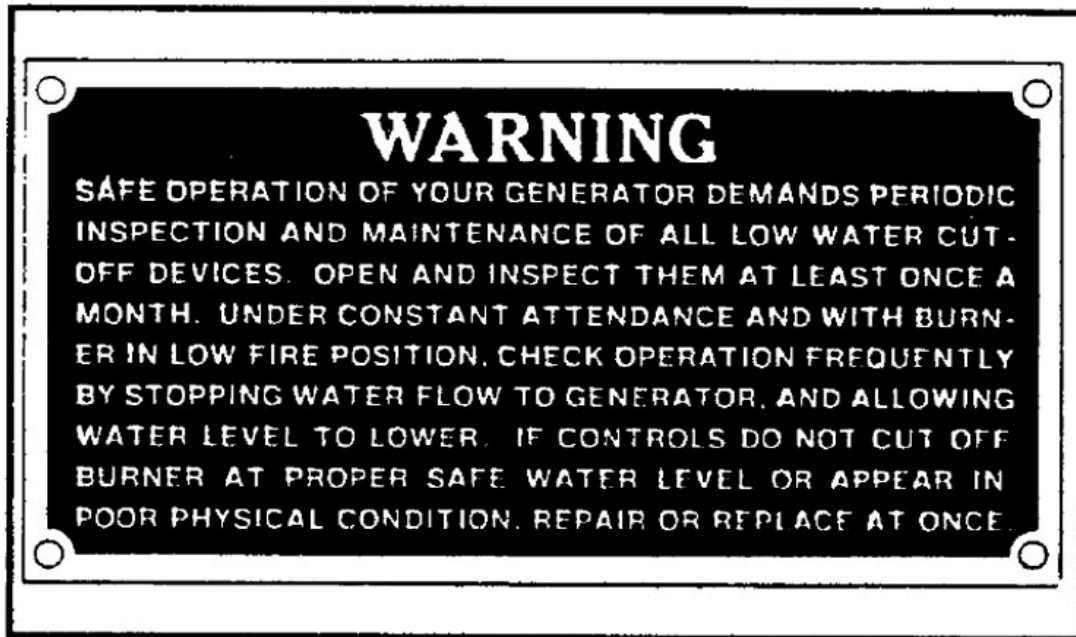


FIGURE 7-1. Low Water Plate

Figure 7-1 is a replica of the low water cut-off plate attached to a steam boiler. These instructions should be followed on a definite schedule. These controls normally function for long periods of time which may lead to laxity in testing on the assumption that normal operation will continue indefinitely.

Water cut-off device(s) should be removed from the bowl at least once a month to check and clean the float ball, the internal moving parts, and the bowl or water column.

Remove the pipe plugs from the tees or crosses and make certain the cross-connecting piping is clean and free of obstructions. Controls must be mounted in a plumb position for proper performance. Determine that piping is vertically aligned after shipment and installation and throughout life of the equipment.

A scheduled blowdown of the water controls on a steam boiler should be maintained.

It is impractical to blowdown the low water cut-off devices on a hot water boiler since the entire water content of the system would become involved. Many hot water systems are fully closed and any loss of water will require make-up and additional feedwater treatment that might not otherwise be necessary. Since the boiler and system arrangement usually makes it impractical to perform daily and monthly maintenance of the low water cut-off devices, it is essential to remove the operating mechanism from the bowl annually or more frequently, if possible,

to check and clean float ball, internal moving parts, and the bowl housing. Also check the cross-connecting piping to make certain that it is clean and free of obstruction.

---

## 7.4 — Water Gauge Glass

A broken or discolored glass should be replaced at once. Periodic replacement should be a part of the maintenance program. Always use new gaskets when replacing a glass. Use a proper size rubber packing. Do not use “loose packing” which could be forced below the glass and possibly plug the valve opening.

Close the valves when replacing the glass. Slip a packing nut, a packing washer, and packing ring onto each end of the glass. Insert one end of the glass into the upper gauge valve body far enough to allow the lower end to be dropped into the lower body. Slide the packing nuts onto each valve and tighten.

If the glass is replaced while the boiler is in service, open the blowdown and slowly bring the glass to operating temperature by cracking the gauge valves slightly. After the glass is warmed up, close the blowdown valve and open the gauge valves completely.

Check the try-cocks and gauge cocks for freedom of operation and clean as required. It is imperative that the gauge cocks are mounted in exact alignment. If they are not, the glass will be strained and may fail prematurely.

---

## 7.5 — Electrical Controls

Most of the operating controls require very little maintenance beyond occasional inspection. Examine the tightness of electrical connections. Keep the controls clean. Remove any dust that accumulates in the interior of the control using a low pressure air hose and taking care not to damage the mechanism.

Examine any mercury tube switch for damage or cracks: this condition, indicated by a dark scum over the normally bright surface of the mercury, may lead to erratic switching action. Make certain that controls of this nature are correctly leveled using the leveling indicator, if provided. The piping leading to those controls actuated by pressure should be cleaned, if necessary. Covers should be left on controls at all times.

Dust and dirt can cause excessive wear and overheating of motor starter and relay contacts, and maintenance of these is a requirement. Starter contacts are plated with silver and are not harmed by discoloration and slight pitting. Do not use files or abrasive materials such as sandpaper on the contact points since it only wastes the metallic silver with which the points are covered. Use a burnishing tool or a hard surface paper to clean and polish contacts. Replacement of the contacts is necessary only if the silver has worn thin.

Thermal relay units (overloads) are of the melting-alloy type and when tripped, the alloy must be given time to re-solidify before the relay can be reset. If overloads trip out repeatedly when the motor current is norm all, replace them with new overloads. If this condition continues after replacement, it will be necessary to determine the cause of excessive current draw.

The power supply to the boiler must be protected with dual element fuses (fusetrons) or circuit breakers. Similar fuses should be used in branch circuits and standard one-shot fuses are not recommended. Information given on the Fuse Sizes Chart (Figure 7-2) is included for guidance to fuse requirements.





**RECOMMENDED MAXIMUM "FUSETRON" FUSE SIZES**

ELECTRICAL LOAD	SINGLE PHASE 50/60 HERTZ		THREE PHASE 50/60 HERTZ					
	110-120 V	220-240 V	200-208 V	220-240 V	346-416 V	440-480 V	550-600V	
1/4 HP MOTOR	FRN - 8	FRN - 4-1/2	FRN - 1-8/10	FRN - 1-8/10		FRS - 1	FRS - 8/10	
1/3 HP MOTOR	FRN - 9	FRN - 4-1/2	FRN - 1-8/10	FRN - 1-8/10		FRS - 1	FRS - 8/10	
1/2 HP MOTOR	FRN - 12	FRN - 6-1/4	FRN - 2-8/10	FRN - 2-8/10	FRS - 1-8/10	FRS - 1-4/10	FRS - 1	
3/4 HP MOTOR	FRN - 17-1/2	FRN - 9	FRN - 4-1/2	FRN - 4-1/2	FRS - 2-1/4	FRS - 1-8/10	FRS - 1-4/10	
1 HP MOTOR	FRN - 20	FRN - 10	FRN - 5	FRN - 5	FRS - 3-2/10	FRS - 2-1/4	FRS - 1-8/10	
1-1/2 HP MOTOR	FRN - 25	FRN - 12	FRN - 7	FRN - 7	FRS - 4	FRS - 3-2/10	FRS - 2-1/2	
2 HP MOTOR	FRN - 30	FRN - 15	FRN - 9	FRN - 9	FRS - 5-6/10	FRS - 4-1/2	FRS - 3-1/2	
3 HP MOTOR	FRN - 40	FRN - 20	FRN - 12	FRN - 12	FRS - 8	FRS - 6-1/4	FRS - 5	
5 HP MOTOR		FRN - 35	FRN - 20	FRN - 20	FRS - 12	FRS - 10	FRS - 8	
7-1/2 HP MOTOR		FRN - 50	FRN - 30	FRN - 30	FRS - 17-1/2	FRS - 15	FRS - 12	
10 HP MOTOR		FRN - 60	FRN - 40	FRN - 35	FRS - 20	FRS - 17-1/2	FRS - 15	
15 HP MOTOR			FRN - 60	FRN - 60	FRS - 30	FRS - 25	FRS - 20	
20 HP MOTOR			FRN - 70	FRN - 70	FRS - 40	FRS - 35	FRS - 25	
25 HP MOTOR			FRN - 90	FRN - 80	FRS - 50	FRS - 40	FRS - 35	
30 HP MOTOR			FRN - 100	FRN - 100	FRS - 60	FRS - 60	FRS - 40	
40 HP MOTOR			FRN - 150	FRN - 150	FRS - 80	FRS - 70	FRS - 50	
50 HP MOTOR			FRN - 175	FRN - 175	FRS - 100	FRS - 80	FRS - 70	
60 HP MOTOR			FRN - 200	FRN - 200	FRS - 125	FRS - 100	FRS - 80	
75 HP MOTOR			FRN - 250	FRN - 250	FRS - 150	FRS - 125	FRS - 100	
100 HP MOTOR			FRN - 350	FRN - 300		FRS - 150	FRS - 125	
125 HP MOTOR			FRN - 450	FRN - 400		FRS - 200	FRS - 150	
150 HP MOTOR			FRN - 500	FRN - 450		FRS - 225	FRS - 200	
200 HP MOTOR				FRN - 800		FRS - 300	FRS - 250	
2 KW HEATER	FRN - 20	FRN - 12	FRN - 7	FRN - 7		FRS - 4-1/2	FRS - 3-2/10	
3 KW HEATER	FRN - 30	FRN - 15	FRN - 10	FRN - 10	FRS - 6-1/4	FRS - 5-6/10	FRS - 4-1/2	
5 KW HEATER	FRN - 60	FRN - 25	FRN - 15	FRN - 15	FRS - 10	FRS - 8	FRS - 6-1/4	
7-1/2 KW HEATER			FRN - 25	FRN - 25	FRS - 15	FRS - 12	FRS - 10	
10 KW HEATER			FRN - 30	FRN - 30	FRS - 25	FRS - 17-1/2	FRS - 12	
15 KW HEATER			FRN - 45	FRN - 45	FRS - 35	FRS - 25	FRS - 20	
CONTROL CIRCUIT XFMR VOLTAGE	1/2 KVA.		1 KVA.		1-1/2 KVA.		2 KVA.	
110-120	FRN - 7		FRN - 15		FRN - 17-1/2		FRN - 25	
200-208	FRN - 4		FRN - 8		FRN - 12		FRN - 15	
220-240	FRN - 3-1/2		FRN - 7		FRN - 10		FRN - 12	
346-416	FRS - 2-8/10		FRS - 4		FRS - 6-1/4		FRS - 8	
440-480	FRS - 2-1/2		FRS - 3-1/2		FRS - 5-6/10		FRS - 7	
550-600	FRS - 2		FRS - 3-1/2		FRS - 4-1/2		FRS - 5-6/10	
SECONDARY FUSE	FRN - 5-6/10		FRN - 12		FRN - 15		FRN - 20	

CONSULT CLEAVER-BROOKS ELECTRICAL ENGINEERING DEPT. FOR "FUSETRON" FUSE SIZE FOR POWER SYSTEMS WITH VOLTAGE, FREQUENCY OR PHASE NOT MENTIONED ABOVE.

DWG. NO. 630-1253  
(REVISED 12/8/88)  
C18-6077

FIGURE 7-2. Fuse Sizes Chart

## 7.6 — Program and Flame Safety Control

This control requires no maintenance since it is a microprocessor system with safety and logic timings that are inaccessible. Neither are there any accessible contacts. Do check to see that the retaining screw is securely holding the chassis to the mounting base. Also check to see that the amplifier and the program module are tightly inserted.

The relay's self-diagnostic ability includes advising when it or its plug-in modules are at fault and require replacement.

In areas of extreme high humidity, your spare control should be stored in a dry atmosphere. During an extended shutdown (e.g., seasonal), the active control should be removed and stored. Moisture can cause problems.

It is recommended that service be rotated between the active and a spare control to assure having a working replacement.

When replacing a control, be sure to open the main power supply switch since the control is “hot” even though the burner switch is off. Make sure the connecting contacts on the control and its base are not bent out of position.

A periodic safety check procedure should be established to test the complete safeguard system at least once a month or more often. Tests should verify safety shutdown and a safety lockout upon failure to ignite the pilot, upon failure to ignite the main flame, and upon loss of flame. Each of these conditions should be checked on a scheduled basis. These tests will also verify fuel valve tightness.

### **7.6.1 — Checking Pilot Flame Failure**

Close the gas pilot shutoff cock. Also shut off the main fuel supply. Turn the burner switch “on.”

The pilot ignition circuit will be energized at the end of the pre-purge period. There should be an ignition spark but no flame. Since there is no flame to be detected, the program relay will signal this condition. The ignition circuit will be de-energized and the control will lockout on a safety shutdown. The flame failure light (and optional alarm) will be activated. The blower motor will run through the post-purge and stop.

Turn the burner switch off. Reset the safety switch. Reopen the gas pilot shutoff cock and re-establish main fuel supply.

### **7.6.2 — Checking Failure to Light Main Flame**

Leave the gas pilot shutoff cock open. Shut off the main burner fuel supply. Turn the burner switch on. The pilot will light upon completion of the pre-purge period. The main fuel valve(s) will be energized, but there should be no main flame.

The fuel valve(s) will be de-energized within 4 seconds after the main burner ignition trial ends. The control will lock out on a safety shutdown. The flame failure light (and optional alarm) will be activated. The blower motor will run through the post-purge and stop.

Turn the burner switch off. Reset the safety switch. Re-establish main fuel supply.

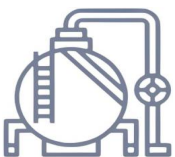
### **7.6.3 — Checking Loss of Flame**

With the burner in normal operation, shut off the main burner fuel supply to extinguish the main flame.

The fuel valve(s) will be de-energized and the relay will signal this condition within 4 seconds. The control will then lockout on a safety shutdown. The flame failure light (and optional alarm) will be activated. The blower motor will run through the post-purge and stop.

Turn the burner switch off. Reset the safety switch. Re-establish main fuel supply.

The flame detector lens should be cleaned as often as operating conditions demand. Use a soft cloth moistened with detergent.



**Courtesy of: C3 Surplus LLC**  
**Surplus Industrial Superstore**  
**305-428-2777**  
**<https://www.c3surplus.com>**

---

## 7.7 — Oil Burner Maintenance

The burner should be inspected for evidence of damage due to improperly adjusted combustion. The setting of the oil nozzle in relation to the diffuser and other components is important for proper firing and should be checked. See Section 5.13 in Chapter 5.

The seal between the burner housing and the oven liner is extremely important. Its condition should be checked periodically and repairs made as necessary.

### 7.7.1 — Oil Strainers

Oil strainers should be cleaned frequently to maintain a free and full flow of fuel.

#### 7.7.1.1 — Light Oil Strainers

The fuel oil strainer screen must be removed and cleaned at regular intervals. It is advisable to remove this screen each month and clean thoroughly by immersing in solvent and blowing dry with compressed air. To remove, loosen the cover cap screw being careful not to lose the copper gasket. Tap the strainer cover gently to loosen. Check the cover gasket. Slip pliers into the cross on the top of the strainer and twist counterclockwise to remove the basket. Reassemble in reverse order.

#### 7.7.1.2 — Heavy Oil Strainers

Keep the cartridge of the Cuno strainer clear by regularly giving the exterior handle one complete turn in either direction. Do this often until experience indicates cleaning frequency necessary to maintain optimum conditions of flow. If it is difficult to turn the handle, rotate back and forth until the handle can be turned through a complete revolution. Do not force with a wrench or other tool.

Drain the sump as often as experience indicates the necessity. Remove the sump, or head and cartridge assembly for thorough cleaning and inspection at frequent intervals. Exercise care not to damage cartridge discs or cleaner blades. Wash the cartridge in solvents. Do not attempt to disassemble the cartridge.

### 7.7.2 — Fuel Oil Treatment

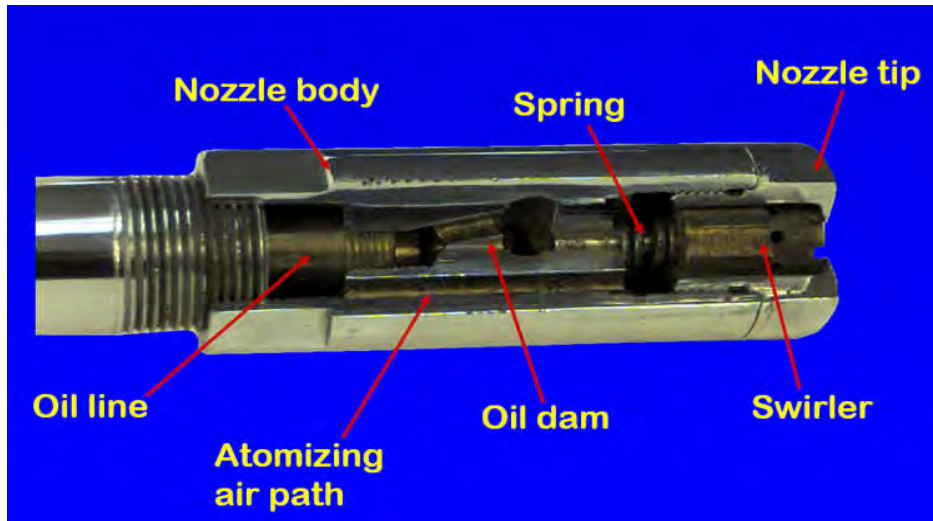
Conditions and the quality of the fuel oil being supplied to the burner may vary to the extent and degree that the use of fuel oil additives may be advisable to obtain proper combustion and to aid in pumping of the oil. The fuel oil storage tank(s) should be checked periodically and cleaned of any sludge deposits.

### 7.7.3 — Cleaning Oil Nozzle

The design of the burner, together with the oil purge system on a heavy oil burner, make it unnecessary to clean the oil nozzle during periods of operation. A routine check should be made during off periods or when the burner is firing on gas and any necessary cleaning performed.

If at any time the burner flame appears “stringy” or “lazy,” it is possible that the nozzle tip or swirler has become partially clogged or worn. Any blockage within the tip will cause the air pressure gauge to increase above its normal value.

To disassemble, unlatch and withdraw the burner gun. Insert the nozzle body into the hanger vice and use the spanner wrench to remove the tip. Carefully remove the swirler and seating spring being careful not to drop or damage any parts.



**FIGURE 7-3. Burner Nozzle Assembly**

Perform any necessary cleaning with a suitable solvent. Use a brush or pointed piece of soft wood for cleaning rather than wire or a sharp metallic object which is apt to scratch or deform the orifices as well as the precision ground surfaces of the swirler and tip. Inspect for scratches or signs of wear or erosion which may make the nozzle unfit for further use. Take the necessary precautions in working with solvents.

The tip and swirler are a matched set which was precision lapped at time of assembly. Do not interchange parts if a spare is kept. In reassembling, make certain that the seating spring is in place and that it is holding the swirler tightly against the tip. The swirler is stationary and does not rotate, but rather imparts a swirling motion to the coil.

**NOTE:** The O-ring in the burner manifold block serves as a seal for the internal oil tube. It is well to replace this item during the annual inspection. At the same time inspect the internal surface of this oil tube. See that the plugged hole is at the bottom of the nozzle body when the gun is installed.

#### **7.7.4 — Air Purge Nozzle (No. 6 Oil), Back Pressure Orifice Nozzle (No. 2 Oil)**

The nozzle and its strainer should be inspected periodically and cleaned. The nozzle consists of a tip and internal core. Clean all internal surfaces of the tip and the slotted parts of the core using a wood splinter to avoid damage from scratching. Replace the core, setting it tightly, but not excessively tight.

Clean the strainer screen carefully to remove any foreign matter. Use suitable solvents in cleaning. Extremely hot water at high velocity is also helpful in cleaning. Replace the strainer by screwing it into the nozzle body only finger tight. Do not use an orifice of a size other than originally installed.

#### **7.7.5 — Ignition System**

Maintain the proper gap and dimensions of the ignition electrode(s) for best ignition results. See Chapter 5, Section 5.13 for correct electrode settings.

Inspect the electrode tip for signs of pitting or combustion deposits and dress as required with a fine file. Inspect the porcelain insulator for any cracks that might be present. If there are, replace the electrode since it can cause

grounding of the ignition voltage. Carbon is an electrical conductor, so it is necessary to keep the insulating portion of the electrode wiped clean. Ammonia will aid in removing carbon or soot.

Check ignition cables for cracks in the insulation. Also see that all connections between the transformer and electrodes are tight.

Periodically remove the access plug from the gas pilot aspirator and clean out any accumulated lint or other foreign material.

---

## 7.8 — Gas Burner Maintenance

There is little maintenance required on the gas burner itself beyond checking the burner components for evidence of damage due to improperly adjusted combustion.

Check periodically for a proper seal between the end of the burner and oven refractory. Also check to see that the diffuser is not covering the gas exit holes in the burner housing.

Check the electrode setting and for any cracks that might be present on the porcelain insulator. If there are, replace the electrode since it can cause grounding of the ignition voltage. Inspect the tip of the electrode for signs of pitting or combustion deposits and dress as required with a fine file. See Chapter 5, Section 5.13 for correct electrode settings.

Periodically remove the access plug from the gas pilot aspirator and clean out any accumulated lint or other foreign material.

Check the ignition cables for cracks in the insulation. Also see that all connections between the transformer and electrodes are tight.

---

## 7.9 — Motorized Gas Valve

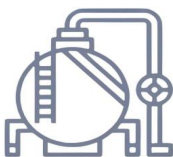
Should the valve fail to operate, check its operation by applying test leads of the proper voltage to terminals 1 and 2 of the actuator. Make certain that the main shutoff cock is closed prior to testing. If the actuator fails to operate, it must be replaced. The actuator is not field repairable nor should it be disassembled.

To remove the actuator, loosen the two 5/32" allen setscrews that hold the actuator collar to the valve bonnet.

After replacement, cycle the valve with the fuel shut off to determine that it opens and closes. If the valve has a visual indicator, observe the colored indicator:

- Yellow = shut
- Red = open

The auxiliary switch normally used as a valve closed indication switch is replaceable as a component.



**Courtesy of: C3 Surplus LLC**  
**Surplus Industrial Superstore**  
**305-428-2777**  
**<https://www.c3surplus.com>**

---

## 7.10 — Solenoid Valves

Foreign matter between the valve seat and seat disc can cause leakage. Valves are readily disassembled; however, care must be used during disassembly to be sure that internal parts are not damaged during the removal and that reassembly is done in proper order.

A low hum or buzzing will normally be audible when the coil is energized. If the valve develops loud buzzing or a chattering noise, check for proper voltage and clean the plunger assembly and interior plunger tube thoroughly. Do not use any oil. Make sure that the plunger tube and solenoid are tight when reassembled. Take care not to nick, dent, or damage the plunger tube.

Coils may be replaced without removing the valve from the line. Be sure to turn off power to the valve. Check the coil position and make sure that any insulating washers or retaining springs are reinstalled in proper order.

---

## 7.11 — Cam Spring

The fuel cam profile spring should be inspected frequently for wear, scoring or distortion. If any of these questionable conditions are found, the spring must be replaced immediately to avoid the possibility of breakage in service. Use care to avoid damaging the spring during installation.

Lubricate occasionally with a non-gumming, dripless, high-temperature lubricant such as graphite or a silicone derivative.

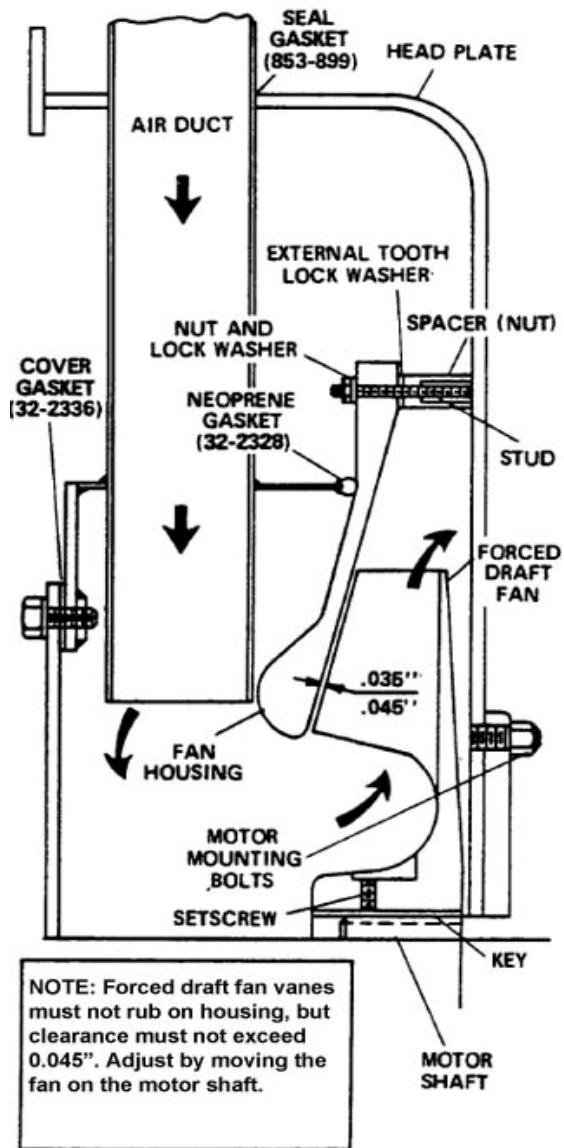
---

## 7.12 — Forced Draft Fan

The position of the fan housing and the clearance between it and the fan (impeller) is extremely important to the output capacity of the fan.

To install and adjust:

1. Bolt the motor securely to the head.
2. Slide the fan onto the shaft, but do not tighten setscrews.
3. Turn spacers on studs until they contact the headplate.
4. Install the fan housing on the studs after placing an external tooth lock washer next to the spacer. Hold the fan housing in place with nuts and lock washers. Tighten by hand. Do not over tighten.
5. Slide the fan until its vanes touch the fan housing. All blades must be against the housing. If necessary, adjust the spacers until the housing is evenly set against all blades. Tighten the nuts to secure the housing in place.
6. Slide the fan toward the motor and use a feeler gauge to obtain a clearance between .035" and .045".
7. Tighten the setscrew on the key first and then tighten the setscrew at 90° from the key.
8. Install the air duct assembly through the opening in the head. Tighten the screws securing the air duct to the fan housing only enough to create a seal between the neoprene gasket and the housing.
9. After connecting the motor leads, check the rotation of the impeller to be sure that it is counterclockwise when viewed from the motor end.



Check occasionally to see that the fan is securely tightened to the motor shaft. Check the clearance between the fan vanes and housing as outlined above. If the boiler is installed in a dusty location, check the vanes for deposits of dust or dirt since these buildups can cause a decrease in air capacity or lead to an unbalanced condition.

FIGURE 7-4. Forced Draft Fan Mounting and Secondary Air Flow

## 7.13 — Safety Valves

The safety valve is a very important safety device and deserves attention accordingly.

The purpose of the valve(s) is to prevent pressure buildup over the design pressure of the pressure vessel. The size, rating, and number of valves on a boiler is determined by the ASME Boiler Code. The installation of a valve is of primary importance to its service life. A valve must be mounted in a vertical position so that discharge piping and Code required drains can be properly piped to prevent buildup of back pressure and accumulation of foreign material around the valve seat area. Apply only a moderate amount of pipe compound to male threads and avoid

over-tightening as this can distort the seats. Use only flat-jawed wrenches on the flats provided. When installing a flange-connected valve, use a new gasket and draw the mounting bolts down evenly. Do not install or remove side outlet valves by using a pipe or wrench in the outlet.

A drip pan elbow or a flexible connection between the valve and the escape pipe is recommended. The discharge piping must be properly arranged and supported so that its weight does not bear upon the valve.

Do not paint, oil, or otherwise cover any interior or working parts of the safety valve. A valve does not require any lubrication or protective coating to work properly.

Follow the recommendations of your boiler inspector regarding valve inspection and testing. The frequency of testing, either by the use of the lifting lever or by raising the steam pressure, should be based on the recommendation of your boiler inspector and/or the valve manufacturer, and in accordance with sections VI and VII of the ASME Boiler and Pressure Vessel Code.

Avoid excessive operation of the safety valve as even one opening can provide a means of leakage. Safety valves should be operated only often enough to assure that they are in good working order. When a pop test is required, raise the operating pressure to the set pressure of the safety valve, allowing it to open and reseal as it would in normal service.

Do not hand operate the valve with less than 75% of the stamped set pressure exerted on the underside of the disc. When hand operating, be sure to hold the valve in an open position long enough to purge accumulated foreign material from the seat area and then allow the valve to snap shut.

Frequent usage of the safety valve will cause the seat and disc to become wire drawn or steam cut. This will cause the valve to leak and necessitate downtime of the boiler for valve repair or replacement. Repair of a valve must be done only by the manufacturer or his authorized representative.

Avoid having the operating pressure too near the safety valve set pressure. A 10% differential is recommended. An even greater differential is desirable and will assure better seat tightness and valve longevity.

Steam is expensive to generate and, for the sake of economy, wastage should be avoided whenever possible.

## 7.14 — Fuel Oil Metering Valve, Adjusting and Relief Valves

In the event that a leak occurs in the packing of the metering valve, the packing nut should be snugged gradually to stop the leak.

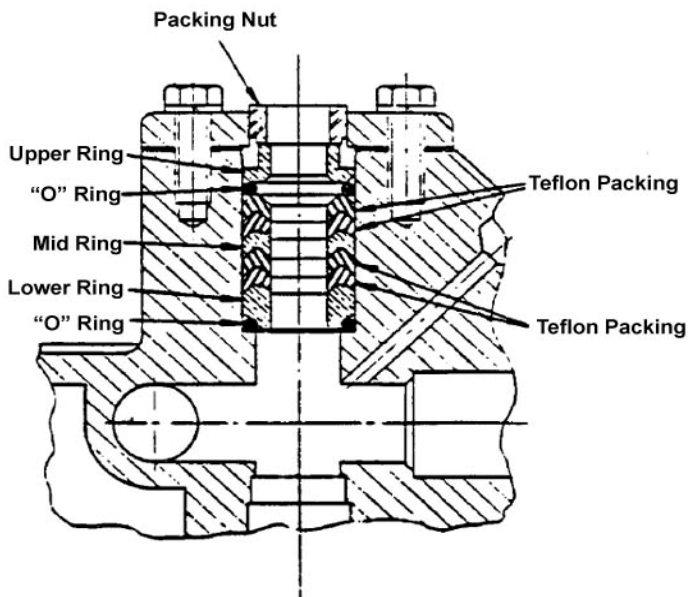
**NOTE:** Excessive tightening of the metering valve packing nut prevents free movement of the metering stem.

If replacement of the metering valve packing is necessary, procure the P/N 880-370 kit and install per the following instructions:

1. Shut off the oil flow. Be sure no pressure shows on the gauge.
2. Match mark the cam hub and drive shaft. This will enable replacement of the cam in its original position and result in a minimum of cam adjustment when the burner is refired.
3. Clamp or hold the metering stem in the down position.



4. Loosen the setscrews in the cam hub and rotate or move the cam to a position where it does not interfere with the stem removal.
5. withdraw the metering valve stem and spring. Do not drop or mishandle. Check for nicks or scratches. Check that the pin holding the metering portion is not protruding. Back off the packing gland.
6. Remove the capscrews holding the jackshaft support bracket so that the bracket can be moved. It may be necessary to also loosen the supporting bracket on the far end of the shaft.
7. Remove the existing packing and guides. Do not reuse these.



8. Lightly coat the stem with the lubricant provided with the packing kit. Place the new packing, o-rings, and guides onto the stem in the sequence shown in Figure 7-5. The beveled face of the guides and the Teflon rings must face upward, with the exception of the upper brass guide which is faced down. Make sure that the o-rings are properly located.

9. Using the stem as a guide, insert the assembled packing into the cavity, then withdraw the stem.

10. Replace the gasket, put the support in place, and secure all fastenings. Install the packing gland.

**FIGURE 7-5. Metering Valve Packing Sequence**

11. Replace the metering stem and spring. Lightly lubricate the stem to facilitate insertion and easy movement. Use care when inserting so that the orifice and the stem are not damaged.
12. Snug the packing gland, but only sufficiently to place slight tension on the packing. The stem must move freely from the force of the spring.
13. Work the stem up and down several times to insure that it is free-moving.
14. Depress the valve stem and replace the cam. Mate the match marks and secure the setscrews. Make sure the cam spring is centered in the roller.
15. Restore the oil flow. Test fire the burner at various firing rates making certain that the metering stem freely follows the cam.
16. Tighten the packing gland after a period of operation, if necessary, to maintain proper tension on the packing. Do not over tighten.

If there are indications that the oil metering valve has become clogged at its orifice, it will be necessary to disassemble the control to remove the obstruction. Clean the slotted stem of the oil metering valve with suitable solvent and blow dry with an air line. Follow the above procedure when removing or reinstalling the metering valve stem. Also check all fuel line strainers.

Should a pressure adjusting or relief valve become clogged, disassemble by releasing the locknut and backing off the screw to relieve tension on the diaphragm. Remove the valve cover and diaphragm. This will expose any dirt or foreign material which may have entered the valves. Clean out carefully and reassemble. It is recommended that the diaphragms be replaced annually.

---

## 7.15 — Air Pump and Lubricating System

### 7.15.1 — Air Pump

The air pump itself requires little maintenance. However, the life of the pump is dependent upon a sufficient supply of clean cool lubricating oil. The oil level in the air-oil tank must be observed closely. Lack of oil will damage the pump making replacement necessary. Disassembly or field repairs to the pump are not recommended.

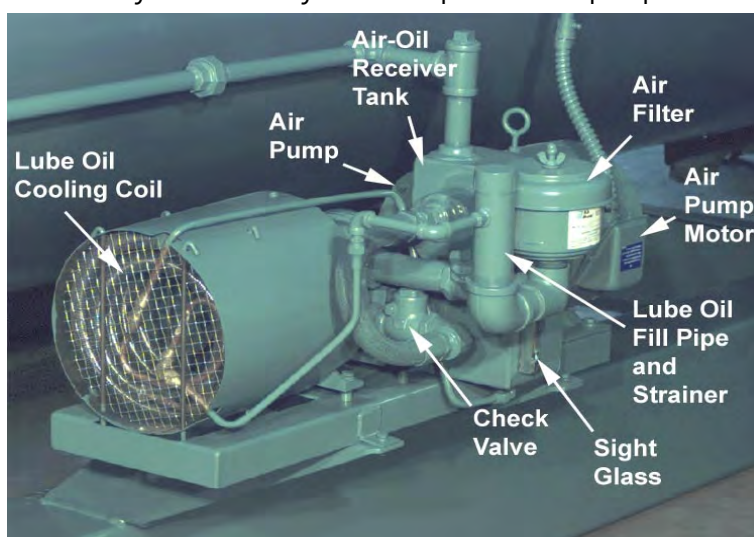


FIGURE 7-6. Air Pump

### 7.15.2 — Lubricating Oil

Lubricating oil must be visible in the gauge glass at all times. There is no specific level required as long as oil is visible. Do not operate if oil is not visible.

Oil with proper viscosity must be used. SAE 20 detergent is recommended, although SAE 10 detergent is also permissible. Name brands known to perform satisfactorily include:

- Havoline (Texaco)
- Mobil Oil (Mobil)
- Shell X100 (Shell)
- Permalube (American)

To add oil:

1. Remove the cover from the fill pipe and add oil through the conical strainer in this pipe with the unit running. Oil must never be added unless the pump is in operation and the strainer screen in place.

- The oil and its container should be clean. although there is a strainer in the lube oil line, its purpose is to remove any unwanted materials rather than to act as a filter for unclean oil.

### 7.15.3 — Lubricating Oil Strainer and Cooling Coil

Air pressure from the pump forces lubricating oil from the tank through a cooling coil to the pump. The oil lubricates the pump bearings and also provides a seal and lubrication for the pump vanes.

The cooled oil flows to the pump through the strainer in the filler pipe. It is possible to visually verify oil flow during operation by removing the filler cap and checking the flow. If necessary, the strainer may be cleaned during operation.

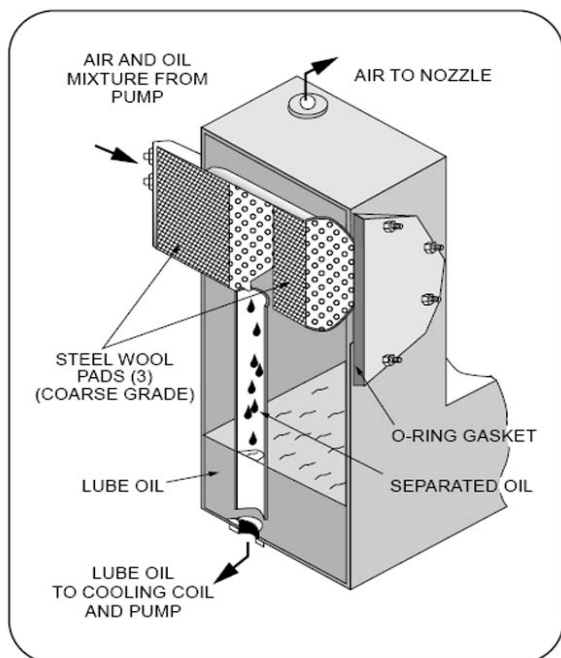
In the event that it is necessary to clean the strainer during operation, clean it and replace immediately. It can be cleaned by immersing it in solvent and blowing it dry with compressed air. Do not operate without the strainer any longer than necessary and never add new oil unless it is in place. A spare strainer basket can be obtained, if desired, and used on a rotating basis while the other is serviced.

There is an orifice fitting installed at the junction of the tubing and the filler pipe. This orifice restricts the flow of lubricating oil to the pump. It must be installed in the event of dismantling during pump replacement or other repair work.

### 7.15.4 — Air Cleaner

Never operate the air pump without the air cleaner (filter) in place. The cleaner itself must be periodically checked and its element flushed and cleaned. The correct level of oil must be maintained in the cleaner.

### 7.15.5 — Air-Oil Tank



Pads of steel wool are used in this tank as a filtering medium to separate the lube oil from the compressed air.

These pads play a very important role and should be replaced periodically. It is also important that a proper grade of steel wool be used. No. 3 coarse grade American steel wool or an equivalent (CB919-124) is recommended. Do not substitute other grades. Three pads are required. When replacing the steel wool, insert two pads into the cylinder. Alternate the grain of the pads. Install the spacer with its stub end toward the opening and fit one pad over the stub. Be careful not to overly compress the steel wool and be sure that it is fluffed out to fill all available space. Improper packing can cause high oil consumption. After the last pad is in place, slip the retainer screen onto the cylinder. Be sure to fit the o-ring gasket under the cover so that a tight seal is obtained.

FIGURE 7-7. Air-Oil Tank

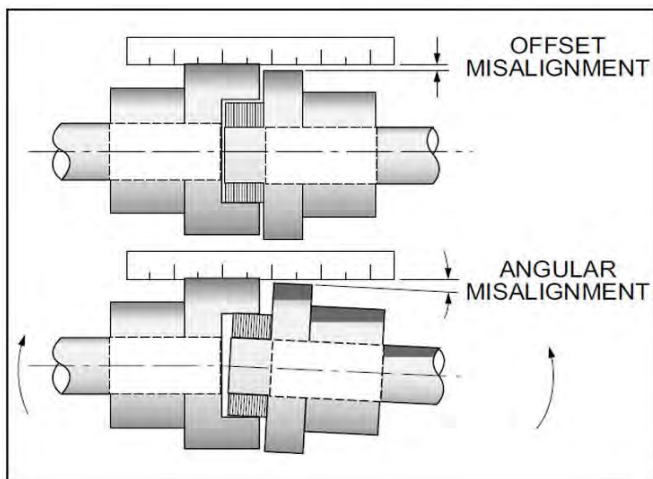
### 7.15.6 — Lube Oil Cooling Coil

The fins on the tubing must be kept clean and free of any dust or dirt that would impede air flow and cause overheating. Use an air hose to blow away debris. Internal cleaning of the tubes is seldom required if a good quality lube oil is used.

### 7.15.7 — Flexible Coupling Alignment

Alignment of the pump and motor through the flexible coupling is of extreme importance for trouble-free operation. Check coupling alignment frequently and replace the coupling insert as required. Keep coupling guard in place.

The most commonly used tools for checking alignment are a small straightedge and a thickness gauge.



The coupling must be checked for both parallel (offset) alignment and angular (gap) alignment. Parallel misalignment exists when shaft axes are parallel but not concentric. Angular misalignment is the reverse situation, the shaft axes are concentric but not parallel.

Checking parallel alignment, both horizontal and vertical, can be accomplished by laying a straightedge across the coupling halves and checking with a thickness gauge to obtain the amount of misalignment. This check should be done on top of the coupling and at least one 90° interval. It is helpful to hold a flashlight behind the straightedge so that any gap can be readily seen.

**FIGURE 7-8. Flexible Coupling Alignment**

Shim stock of appropriate thickness and area is then used under either the feet of the pump or the motor to establish parallel alignment. A tolerance of .008" is a permissible limit.

After parallel alignment is established, check for angular alignment. This is done by checking the gap between coupling halves. The coupling should have a minimum gap of 1/16" and a maximum of 3/32".

Set the spacing between the halves one point by using a thickness gauge and then rotate the coupling slowly to be sure that the halves are the same distance apart at all points. Adjust to obtain proper gap by loosening the hold-down bolts and shifting either the pump or the motor as required. Generally, a slight tapping on either the front or rear legs is all that is needed to obtain lateral adjustment. Rear legs may require shimming for vertical correction.

Tighten the hold-down bolts after adjustments are made.

Calipers can also be used in checking angular alignment. Measure the overall distance of the outer ends of the coupling halves at 90° intervals. Shift the pump or motor as required so that the ends of the coupling are the same distance apart at all points. The coupling will then have proper angular alignment.

Remember that alignment in one direction may alter the alignment in another. Recheck thoroughly both angular and parallel alignment procedures after making any alterations.

A properly aligned coupling will last a long time and will provide trouble-free mechanical operation.

### 7.15.8 — Air Pump Replacement

Use the following procedures to replace the pump, and be sure to tag the motor leads, if disconnected, to simplify reconnection.

#### *Dismantling*

1. Lift out the two front cylinder pins that hold the screen and remove the screen.
2. Disconnect the flared nut on the tubing (behind the screen) and lift the tubing high enough to prevent drainage of lubricating oil from the tank.
3. Disconnect the flared nut at the orifice fitting.
4. Remove the two sheet metal screws that hold the cylinder in place. One screw is located at the top rear of the cylinder, the other is at the bottom front.
5. Remove the entire heat exchange assembly consisting of the cylinder, the finned tubing, and the oil line.
6. Remove the fan from the air pump.
7. Disconnect the flexible air line from the lube tank.
8. Remove the coupling guard by pushing in on both sides until it clears the clamp.
9. Loosen the clamp at the rear of the tank and remove the tank with the copper tubing attached,
10. Leave the rear pump bracket (coupling end) in place to aid in realignment of the replacement pump. Do this by removing the two cap screws that extend through the bracket into the pump housing. Temporarily leave the front bracket attached to the pump.
11. Remove the screws holding the front bracket to the base and lift off the pump with its attachments. Note the location of the pipe fittings and brackets prior to removing for installation of the replacement pump. If the piping is dismantled, be sure that the check valve is reinstalled so that the gate swings towards the pump.

#### *Reassembly*

Reassembly should take place in reverse order of disassembly. With the rear pump bracket left in place, realignment and spacing between the pump shaft and the motor shaft is greatly simplified.

There should be approximately 7/8" space between the two shafts. Place the coupling insert between the coupling halves prior to reassembly. Check to see that both shafts rotate freely.

If shims were used originally under either pump brackets or motor feet, be sure that they are correctly reinstalled.

When reinstalling the fan, slide the hub on the pump shaft so that it is bottomed. Tighten the setscrew and cap-screws. If the fan blades were removed from the hub, make sure that the side of the blade marked "Blower" faces the hub when reassembling. When tightening the coupling halves or the fan hub, tighten the setscrews against the key first, then tighten the setscrew against the shaft. Clean or remove any dust or grime from the blades prior to reinstalling.

When replacing the retainer screen, a slight force may be required to push the cooling coil into the air cylinder so that pins may be fitted into place.

Make sure that all piping connections are tight.

If the motor was replaced or if the motor leads were disconnected, make sure that pump rotation is proper before starting operation. The air pump should rotate in a clockwise direction when viewed from the drive shaft end.

Keep the motor and other components free from dust and dirt to prevent overheating and damage. Motor lubrication should follow manufacturer's recommendations.

---

## 7.16 — Refractory

The boiler is shipped with a completely installed refractory. This consists of the rear head, the inner door, and the furnace liner. Normal maintenance requires little time and expense, and prolongs the operating life of the refractory.

Preventive maintenance through periodic inspection will keep the operator informed of the condition of the refractory and will guard against unexpected and unwanted downtime and major repairs.

Frequent wash-coating of refractory surfaces is recommended. High temperature bonding air-dry mortar, diluted with water to the consistency of light cream, is used for this purpose. Recoating intervals will vary with operating loads and are best determined by the operator when the heads are opened for inspection.

### 7.16.1 — Furnace Liner

Maintenance consists of occasional wash-coating of the entire liner. Face all joints or cracks by applying high temperature bonding mortar with a trowel or fingertips. This should be done as soon as cracks are detected.

Should segments of the liner burn away or fall out, replace the entire refractory. Any refractory that may break out should be removed as soon as detected so that it will not fuse to the bottom of the furnace and obstruct the flame.

If replacement is necessary, refer to Chapter 8 and order proper replacement materials. Remove the existing refractory. Thoroughly clean the furnace to remove all old refractory cement or other foreign material to insure new liner seating firmly to the steel. Inspect the furnace metal for soundness.

Depending upon the design pressure of the boiler, the furnace may be of the corrugated type. Although it is not necessary to fill in the depressions, for convenience of installation some or all of the corrugation valleys may be filled with insulating cement. The liner tile should be fitted tightly against the crown of the corrugations.

### 7.16.2 — Liner Installation

The segments are normally replaced through the front opening in the furnace and it is suggested that the rear most course be installed first, the middle next, and finally the throat tile at the entrance of the furnace. When the three courses are installed, the entire liner should be pulled or pushed forward so that it is flush with the flange ring at the mouth of the furnace.

It is recommended that the tile be dry fitted, match marked, removed, and then reinstalled with the proper amount of refractory cement. Thin joints are desirable. Generally, it will be necessary to shave a portion from one or more tile to obtain a fit. If a fill piece is required, cut it to fit and install this piece at the bottom of the furnace.

The area between the burner housing and the throat tile requires a good seal. An improper or poor seal allows air leaks that can cause overheating and burning of the burner housing metal. This area should be inspected at frequent intervals.

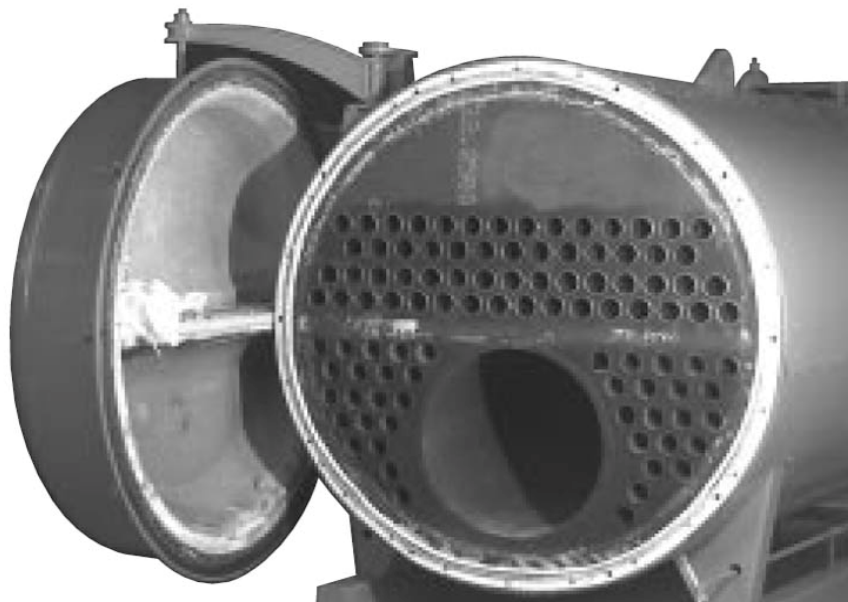
When installing the housing, or the tile against the housing, liberally coat this surface with refractory cement. Remove any cement that is squeezed out so that it does not cover the gas holes in the housing.

Allow the refractory to air dry as long as possible. If immediate use is required, fire intermittently at low rate for several hours to thoroughly dry the refractory.

For detailed information, request Bulletin C10-5921.

### 7.16.3 — Rear Door

The rear door is a steel shell containing horizontal baffle tiles and lined with insulation material and castable refractory.



**FIGURE 7-9. Rear Door Open**

Burned or discolored paint on the outer surface of the door does not necessarily indicate refractory trouble, but may be an indication of other conditions, such as:

- Leaking gaskets.
- Improper seal.
- Door retaining bolts insufficiently or unevenly tightened.
- The air line to the rear sight tube may be blocked or loose.
- Repainted with other than heat resistant paint.

Therefore, before assuming the refractory requires reworking:

- Check condition of tadpole gasket and rope seal.

- Check condition of insulating cement protecting the tadpole gasket.
- Check the horizontal baffle tile for large cracks, breaks, chipped corners, etc.
- Check for cracks in castable refractory at ends of baffle tile.
- Check tightness of door bolts.
- See that the air line to the sight tube is clear and connections are tight. If necessary, blow clear with an air hose.

It is normal for refractories exposed to hot gases to develop thin “hairline” cracks. This by no means indicates improper design or workmanship. Since refractory materials expand and contract to some degree with changes in temperature, they should be expected to show minor cracks due to contraction when examined at low temperature. Cracks up to approximately 1/8” across may be expected to close at high temperature. If there are any cracks that are relatively large (1/8” to 1/4” in width), clean them and fill with high temperature bonding mortar. Any gap that may show between the castable refractory and the baffle tile should be filled in a similar fashion.

After opening the rear door, clean the flange with a scraper or wire brush. Clean the surface of the refractory carefully with a fiber brush to avoid damaging the surface. Clean the mating surfaces of the baffle tile and the boiler shell. Remove all dried out sealing material. Wash-coat the lower half of the rear door refractory prior to closing.

The upper half of the door contains a lightweight insulating material similar to that used in the inner door. A thin wash-coat mixture applied gently with a brush is helpful in maintaining a hard surface.

If the baffle tile or the refractory requires replacement, contact your local Cleaver-Brooks representative.

#### **7.16.4 — Front Inner Door**

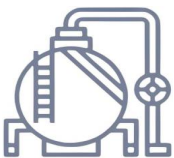
The front inner door is lined with a lightweight castable insulation material. Thin “hairline” cracks may develop after a period of time. However, these will generally tend to close due to expansion when the boiler is fired.

A thin wash-coat mixture applied gently with a brush is helpful in maintaining a hard surface.

Minor repairs can be accomplished by enlarging or cutting out affected areas, making certain that they are clean and then patching as required. Should the entire installation require replacement, remove existing material and clean to bare metal. Inspect the retaining pins and replace if necessary. Reinforcing wire suitably attached may also be used. The recommended insulation is known as Vee Block Mix and is available in 50 lb. bags (CB part number 872-162).

Mix the material with water to a trowling consistency. Mixing should be completely uniform with no portion either wetter or drier than another. Trowel this mixture into any areas that are being patched. If replacing complete insulation, begin at the bottom of the door and apply the mixture to a thickness equal to the protecting shroud. With a trowel apply horizontally back and forth across the door in layers until the required thickness is reached.

Allow to air dry as long as possible. If immediate use of the boiler is required, fire as slowly as possible to avoid rapid drying of the material.



**Courtesy of: C3 Surplus LLC**  
**Surplus Industrial Superstore**  
**305-428-2777**  
**<https://www.c3surplus.com>**

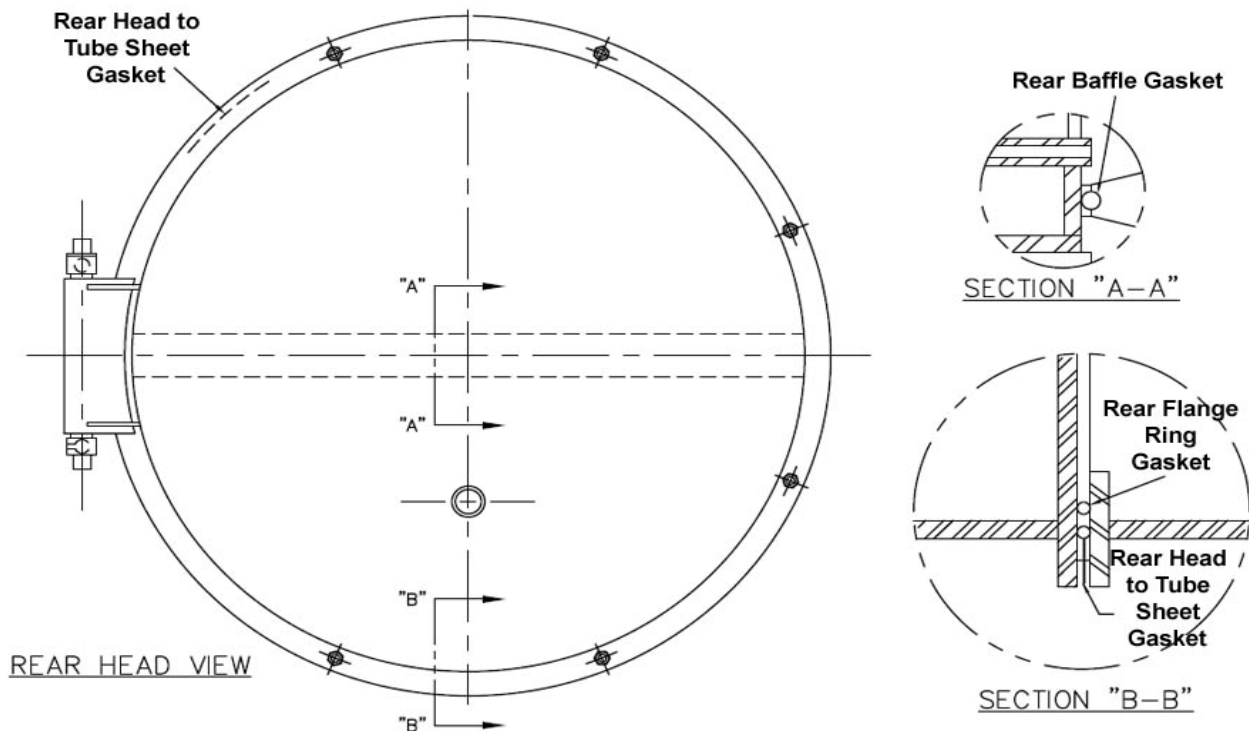


## 7.17 — Opening and Closing Rear Head

A good seal between the rear head (door) and the pressure vessel is necessary to prevent leakage of combustion gases, loss of heat, and to aid in obtaining operating efficiency. Leaks can also cause hot spots that can lead to premature refractory failure and/or damage to the door metal.

When opening the door, either for routine maintenance or for an annual inspection, do not do so when the boiler or the head is hot. The refractory will hold its temperature for some time and exposure to ambient temperature or rapid cooling may cause refractory cracking and/or harm to the boiler and door metal.

The opened door should be supported by blocking or jacking to eliminate possible deformation.



**FIGURE 7-10. Rear Door Sealing**

Prior to closing, check all gaskets and sealing surfaces. If the door gasket is hard or brittle, it should be replaced. The fiberglass ropes used for the baffle seal and for the door gasket seal should not be reused. The door flange and the tube sheet area of the baffle seal should be clean and free of old sealing material, scale, etc. Make sure that all of the gasket retaining fasteners are in place.

Remove the old rope and insulating cement from the baffle tile or refractory. Be careful not to chip or crack the refractory. The rope is placed on top of the lip of the tile baffle.

Attach a new length of 1-1/4" diameter fiberglass rope (P/N 853-982) to the baffle. Be certain that it is properly positioned and use a rapid setting adhesive (P/N 872-481) to hold it in place.

**NOTE:** A boiler built for high pressure design, such as 150 psi or higher steam or for 60 psi or higher hot water, is constructed with a flanged tube sheet that fits inside of the boiler shell and door flange.

The area between the curved portion of the sheet and the flange is packed with fiberglass rope and covered with cement to fill this void and to provide a smooth sealing area.

Replacement is not normally necessary, but if it is, completely remove all old material. Firmly caulk a layer of 1/4" diameter rope (P/N 853-348) into this area. Tamp a second layer over the first. Apply a coating of insulating cement pulp (P/N 872-26) over the ropes to form a smooth surface. If time permits, allow this to harden before closing the door.

### **7.17.1 — Closing and Sealing**

Coat the door gasket with an oil and graphite mixture. Apply a small amount of a pulp mixture consisting of cement (P/N 872-26) and water around the inner circumference of the gasket. Press rope into this area. Use 1/2" diameter rope (P/N 853-996) for a boiler of low pressure design. Use 1" diameter rope (P/N 853-999) for a high pressure boiler.

After the rope is installed, the entire rope and gasket area, and the baffle area, should be liberally coated with the pulp mixture. When the door is closed, the pulp will compress to protect the tadpole gasket and form a seal between the refractory surface and the tube sheet.

Door bolts should be run in snug and tightened evenly to avoid cocking the door and damaging the gasket. Start tightening at top center and alternate between the top and bottom bolts until both are tight. Do not over-tighten. Tighten alternate bolts until the door is secured and gas tight. After the boiler is back in operation, retighten the bolts to compensate for any expansion.

---

## **7.18 — Lubrication**

### **7.18.1 — Electric Motors**

Manufacturers of electric motors vary in their specifications for lubrication and care of motor bearings, and their recommendations should be followed.

Ball bearing equipped motors are pre-lubricated. The length of time a bearing can run without having grease added will depend upon many factors. The rating of the motor, type of motor enclosure, duty, atmospheric conditions, humidity, and ambient temperatures are but a few of the factors involved.

Complete renewal of the grease can, when necessary, be accomplished by forcing out the old grease with the new. Thoroughly wipe those portions of the housing around the filler and drain plugs (above and below bearings). Remove the drain plug (bottom) and free the drain hole of any hardened grease which may have accumulated. With the motor not running, add new grease through the filler hole until clear grease starts to come out of the drain hole. Before replacing the drain plug, run the motor for 10 to 20 minutes to expel any excess grease. The filler and drain plugs should be thoroughly cleaned before they are replaced.

The lubricant used should be clean and equal to one of the good commercial grades of grease locally available. Some lubricants that are distributed nationally are:

- Gulf Oil — Precision Grease No. 2
- Humble Oil — Andok B
- Texaco — Multifak No. 2
- Phillips — 1B + RB No. 2
- Fiske Bros. — Ball Bearing Lubricant
- Standard/Mobil — Mobilux No. 2

### 7.18.2 — Control Linkage

Apply a non-gumming, dripless, high temperature lubricant, such as graphite or a silicone derivative to all pivot points and moving parts. Work lubricant in well and wipe off any excess. Repeat application at required intervals to maintain freedom of motion of parts.

Solenoid valves and motorized valves require no lubrication.

---

## 7.19 — Oil Heaters: Electric, Steam, Hot Water

Maintenance of these heaters consists primarily of removing the heating element from the shell and scraping any accumulation of carbonized oil or sludge deposits that may have collected on the heat exchanging surfaces.

Before breaking any of the electrical connections to the electric heating elements, mark all wires and terminals to assure rapid and correct replacement of wires.

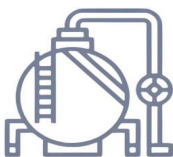
Finish the cleaning process with ammonia to cut all hardened deposits from the heater element. Because of the insulating effect of carbon and sludge, periodic cleaning is necessary to prevent overheating of the elements. If operation of the heater becomes sluggish, examine the elements at once and clean as required.

Inspect the shell or tank each time the heater is removed. Flush all accumulated sludge and sediment from the tank before reinstalling the heater.

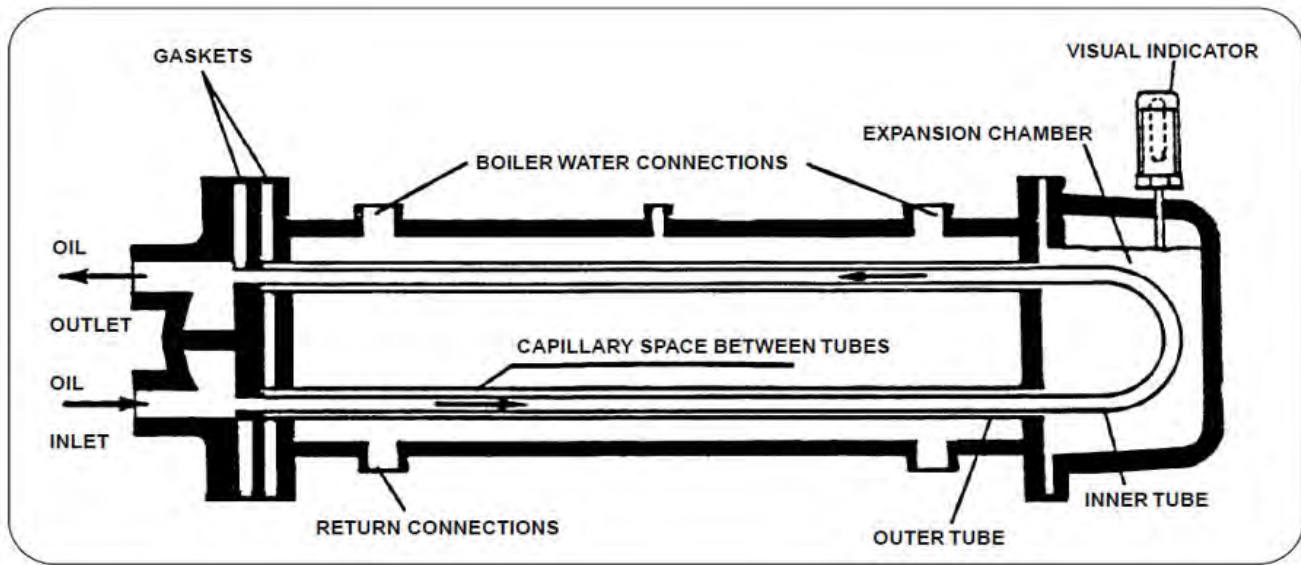
The condensate from steam oil heaters must be safely discharged to waste. This waste should be checked periodically for any traces of oil which would indicate leaking tubes within the heater.

The hot water oil heater (Figure 7-11) contains a heat transfer solution. Oil flows through an inner tube while boiler water surrounds the outer tube. The space between the two tubes is filled with the heat transfer solution and is connected to a chamber on the rear of the heater. A visual indicator on this chamber reveals the presence of any oil should an oil leak occur.

A 50/50 solution of permanent anti-freeze and water is generally used as the heat transfer solution, although if there is no danger of freezing, plain water may be used as a replenishment if necessary to refill.

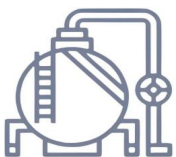


**Courtesy of: C3 Surplus LLC**  
**Surplus Industrial Superstore**  
**305-428-2777**  
**<https://www.c3surplus.com>**

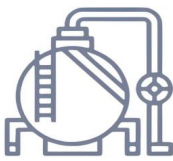


**FIGURE 7-11. Circulation Layout of Hot Water Oil Heater (Alstrom)**

Evidence of oil in either the steam heater condensate or in the water heater indicator demands prompt repairs.



**Courtesy of: C3 Surplus LLC**  
**Surplus Industrial Superstore**  
**305-428-2777**  
**<https://www.c3surplus.com>**



### 8.1 — Ordering Parts

Be sure to furnish complete information when ordering parts. Include the boiler serial number (displayed on the name plate which is attached to the front of the boiler) on your order. The order should state:

- the Cleaver-Brooks part number
- the name and description of the required part
- the quantity required
- method of shipment
- date the part(s) is needed by

**CleaverBrooks®**

SERIAL NO.

MODEL NO.

SERIAL NO.

BTU. INPUT

BTU. OUTPUT

**BOILER**

DATE

OIL  GPH

NAT. GAS  CFH

PRESSURE  PSI

**CleaverBrooks®**

MILWAUKEE, WISCONSIN, U.S.A.

FIGURE 8-1. Name Plate

If repair parts are required for accessory equipment, such as an electric motor, pump, etc., which may not be shown, be sure to give the complete name plate data from the item for which the parts are required.

### 8.1.1 — Where to Order Parts

Repair or replacement parts should be ordered from your Cleaver-Brooks representative or directly from Cleaver-Brooks.

### 8.1.2 — Returning Parts for Repair

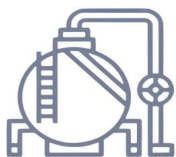
Parts to be repaired should be directed to your Cleaver-Brooks representative or directly to Cleaver-Brooks. A purchase order or a letter authorizing repairs and giving complete details should be mailed to your representative or directly to Cleaver-Brooks. Prior to returning, please remove fittings or accessories from the component, properly drain and clean the part to comply with shipping regulations and include a packing slip identifying the part with your company's name.

If you desire to return parts for reasons other than repair or exchange, please contact your representative or Cleaver-Brooks and state the reasons for the return and await permission and directions prior to returning the material.

### 8.1.3 — Factory Rebuilt Parts

Many controls and other components can be factory rebuilt (FR) or have a trade-in value. These items are available on an exchange basis. Consult your Cleaver-Brooks representative or Cleaver-Brooks for information and prices.

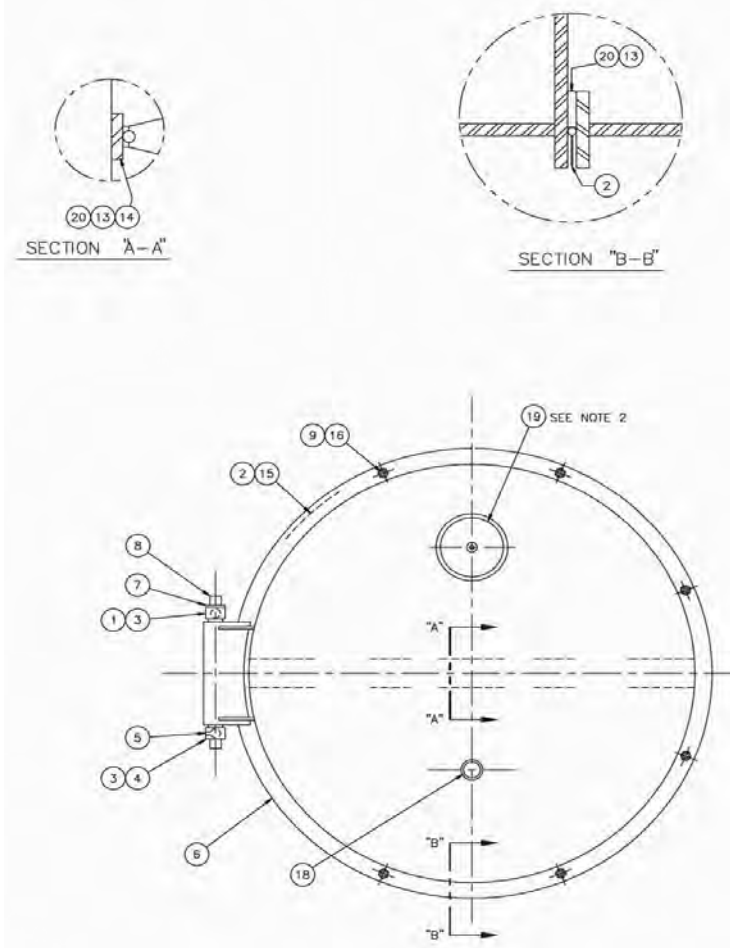
Be sure to show the serial number of your boiler on all parts orders and correspondence.



**Courtesy of: C3 Surplus LLC**  
**Surplus Industrial Superstore**  
**305-428-2777**  
**<https://www.c3surplus.com>**

## 8.2 — Parts Lists

### 8.2.1 — Rear Head Sealing



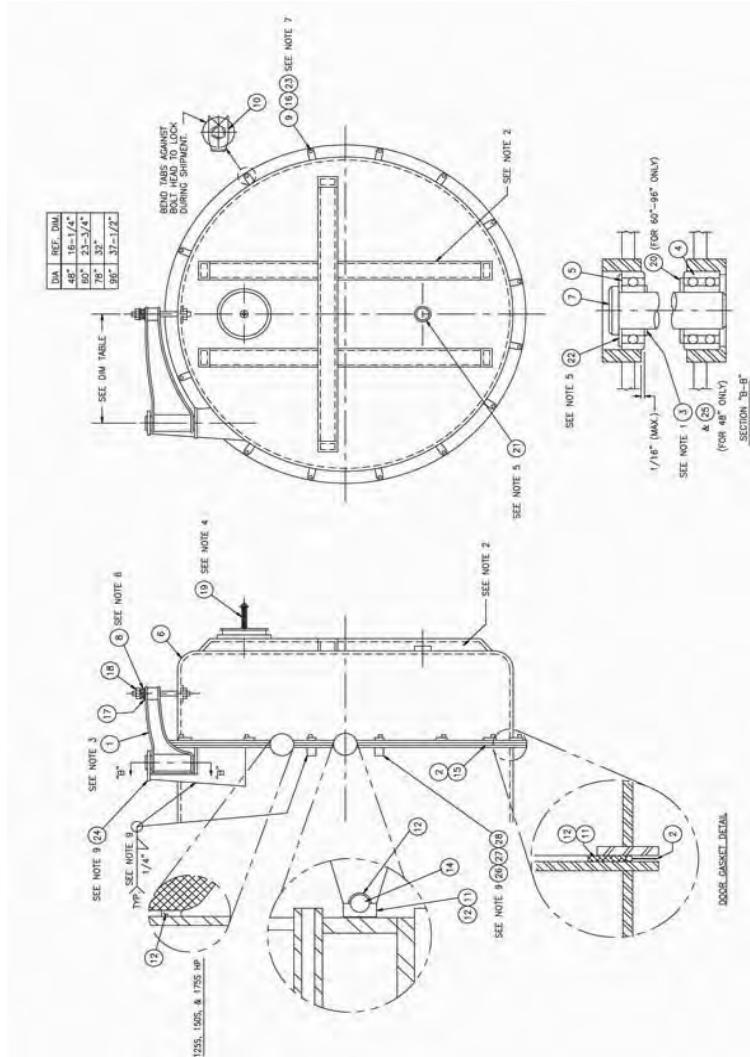
ITEM	QTY.	PART NO.	DESCRIPTION	USED ON
(1)	1	7-A-44	EYEBOLT, UPPER	—
(2)	1	32-A-2568	GASKET FRONT AND REAR HEAD	—
(3)	2	869-145	NUT, HEX, JAM, 1-1/4"-7"	—
(4)	1	7-A-9	EYEBOLT, LOWER	—
(5)	1	860-236	SETScrew, 1/2-13 X 1" LG.	—
(6)	1	SEE TABLE	HEAD, REAR INSULATED	—
(7)	1	914-147	RING, RETAINER	—
(8)	1	56-A-254	HINGE PIN	—
(9)	8	868-94	CAPSCREW, HEX. HD. 5/8"-11 X 4-1/2" LG.	—
(10)	—	—	—	—
(11)	—	—	—	—
(12)	—	—	—	—
(13)	12 OZ.	872-481	ADHESIVE	—
(14)	4 FT.	853-982	ROPE - 1-1/4" DIA.	—
(15)	24	841-507	FASTENER, ALVECO NO. 1202	—
(16)	6	952-230	WASHER, SPECIAL, 3/32" THK. STL.	—
(17)	26 FT.	853-348	ROPE - 1/4" DIA.	—
(18)	1	550-A-42	CAP, SIGHT HOLE ASSEMBLY	—
(19)	1	428-A-17	COMBUSTION RELIEF DOOR, 7"	—
(19)	1	428-A-37	COMBUSTION RELIEF DOOR, 12"	—
(20)	16.8 FT.	872-1073	607 MAX BLANKET 1/2" THK X 2" WIDE	—

TABLE ITEM (6)		
	PART NO.	USED ON
W/O RELIEF DOOR	465-D-2615	RH. U.S. & CANADA
	465-D-2616	LH. U.S. & CANADA
	465-D-2625	CB100S
W/ RELIEF DOOR	465-D-2617	RH. U.S. & CANADA W/7" DOOR
	465-D-2619	RH. U.S. & CANADA W/12" DOOR
	465-D-2618	LH. U.S. & CANADA W/7" DOOR
	465-D-2620	LH. U.S. & CANADA W/12" DOOR



Courtesy of: **C3 Surplus LLC**  
**Surplus Industrial Superstore**  
**305-428-2777**  
<https://www.c3surplus.com>

### 8.2.2 — Rear Head Sealing - Davit



BILL OF MATERIAL FOR 48" DIA. BOILER (NON-STANDARD)					
ITEM	QTY.	PART #	DESCRIPTION	USED ON	OPTION
1	1	287-C-56	DAVIT ARM ASSEMBLY, REAR R.H.	JA	
2	1	32-A-2548	GASKET FRONT AND REAR HEAD	JA	
3	2	852-235	WASHER, 1-1/8" O.D. X 1/16"		
4	1	807-64	BEARING BALL - DOUBLE ROW	JA	
5	1	807-65	BEARING BALL - SINGLE ROW	JA	
6	1	SEE TABLE	HEAD, REAR INSULATED	JA	
7	1	58-A-25	PIN, HINGE DAVIT - REAR	JA	
8	-	NOT USED	NOT USED FOR 48" DIA. BOILER		
9	8	888-84	CAPSCREW, HD, 3/8-11 X 4-1/2" LG.		
10	1	03A35	REAR HEAD BOLT RETAINER	A2	
11	1	797-1813	ADHESIVE		
12	16.5 FT	872-1073	607 MAX BLANKET 1/2" X 2"		
13	-	-	-		
14	4 FT.	853-1036	ROPE - 1-1/2" DIA.		
15	24	841-507	FASTENER, ALUMED NO. 1202		
16	6	952-230	WASHER, SPECIAL, 3/32" THK. STL.		
17	1	952-238	WASHER, FLAT, 3/4" BRASS		
18	1	869-160	NUT, LOCKNUT, 3/4"-10 STEEL		
19	1	428-A-17	COMBUSTION RELIEF DOOR, 7" OPTIONAL	48, 47	
20	-	NOT USED	NOT USED		
21	1	550-A-42	CAP. SHORT HOLE ASSEMBLY	JA	
22	1	914-147	RING, RETAINER	JA	
23	-	NOT USED	NOT USED FOR 48" DIA. BOILER		
24	1	88-C-3166	SUPPORT, PEDISTAL	R.H. SWING	
25	2	352-234	SUPPORT, PEDISTAL	L.H. SWING	
26	2	65-A-308	WASHER, 1-1/8" O.D. X 10.3 1/32"		
27	2	51-A-100	NUT, HEAD BOLT		
28	2	903-87	COTTER PIN, 5/32" X 2" LG.	JA	

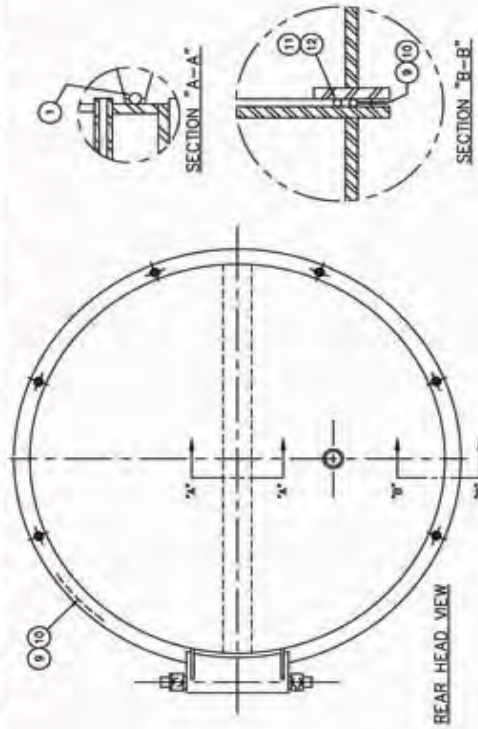
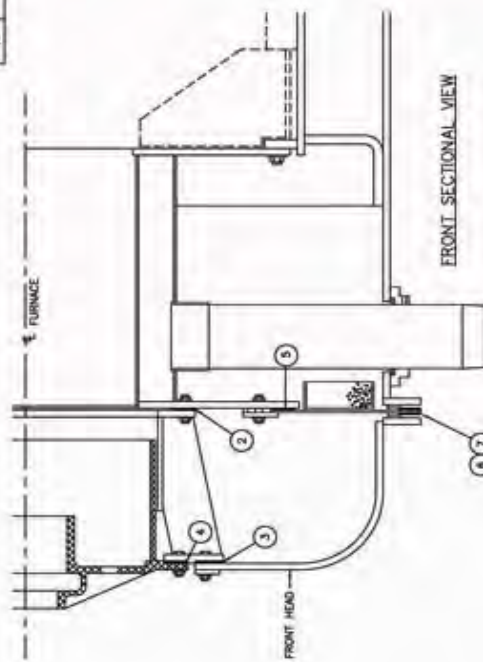
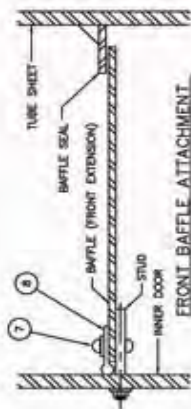
TABLE ITEM 6 (FLAT T.S.)	
PART NO.	USED ON
465-2621	50-100 HP - U.S. & CAN.
465-2625	100S, HP
465-D-2075	125S, 150S, 175S & 125-200HP CBR
465-2083	125-200 HP - U.S. & CAN. CB/LE
465-D-2381	250-350 HP. - U.S. & CAN.
465-D-2177	400-800 HP. CB - U.S. & CANADA
465-D-2493	400-800 HP/CB/LE - U.S. & CANADA
465-2622	50-100HP - U.S. & CAN. W/ 7" DOOR
465-2623	50-100HP - U.S. & CAN. W/ 12" DOOR
465-2084	125-200HP - U.S. & CAN. W/ 7" DOOR CB/LE
465-2144-04	125-200HP - U.S. & CAN. W/ 12" DOOR CB/LE
465-2468	250-350 HP. - U.S. & CAN. W/12" DOOR
465-2178	400-800 HP CB - W/12" DOOR U.S. & CANADA
465-2494	400-800 HP/CB/LE - W/12" DOOR U.S. & CANADA



### 8.2.3 — Fireside Gasket

C.B. 48" DIA. FIRESIDE GASKET BILL OF MATERIAL

KIT	DATE OF BOILER MANUFACTURE				DATE OF BOILER MANUFACTURE				DATE OF BOILER MANUFACTURE				
	3-17-99 TO PRESENT		12-17-74 TO 3-18-99		12-17-74 TO 3-18-99		12-17-74 TO 3-18-99		12-17-74 TO 3-18-99		12-17-74 TO 3-18-99		
ITEM	QTY	PART No.	QTY	PART No.	QTY	PART No.	QTY	PART No.	QTY	PART No.	QTY	PART No.	DESCRIPTION
1	1	853-00984	1	853-00984	1	853-00984	1	853-00984	1	853-00984	1	853-00984	GASKET, REAR BAFFLE
2	1	032-02332	1	032-02332	1	032-02332	1	032-00518	1	032-00518	1	032-00518	GASKET, BURNER HOUSING TO DRAMMER SUPPORT
3	72	UG 853-00903	72	UG 853-00903	72	UG 853-00903	1	032-00567	1	032-00567	1	032-00567	GASKET, BURNER SUPPORT TO FRONT HEAD
4	1	032-00605	1	032-00605	1	032-00605	1	032-00553	1	032-00553	1	032-00553	GASKET, BURNER DRAWER TO SUPPORT
5	1	032-02333	1	032-02333	1	032-02333	1	032-00517	1	032-00517	1	032-00517	GASKET, BURNER HOUSING TO INNER DOOR
6	2	032-00518	2	032-00518	2	032-00518	2	032-00516	2	032-00516	2	032-00516	GASKET, FRONT HEAD TO INNER DOOR
7	50	841-00551	50	841-00551	50	841-00551	50	841-00551	50	841-00551	50	841-00551	RYLET, SPLIT, INNER DOOR & BAFFLE GASKET
8	1	853-00992	1	853-00992	1	853-00992	1	853-00992	1	853-00992	1	853-00992	GASKET, FRONT BAFFLE
9	1	032-02568	1	032-02568	1	032-02568	1	032-00516	1	032-00516	1	032-00516	GASKET, REAR HEAD TO TUBE SHEET
10	25	841-00507	25	841-00507	25	841-00507	25	841-00507	25	841-00507	25	841-00507	PASTER, REAR HEAD TO TUBE SHEET GASKET
11	-	N/A	-	N/A	-	N/A	-	N/A	-	N/A	-	N/A	GASKET, REAR FLANGE RING
12	1	853-01006	1	853-01006	1	853-01006	1	853-01006	1	853-01006	1	853-01006	GASKET, REAR FLANGE RING

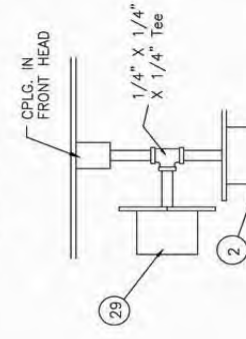


### 8.2.4 — Front Head Electrical

ITEM	QTY	PART NO.	DESCRIPTION	USED ON
1	1	SEE TABLE	BLOWER MOTOR	—
2	1	817-3446	CAPS	HAWK ICS VSD
3	1	817-4133	SCANNER ASSEMBLY	—
4	1	292-95	IGNITION CABLE	GAS & COMB.
5	1	292-98	IGNITION CABLE	OIL ONLY
6	1	832-118	IGNITION TRANSFORMER	ALL 60 HZ
7	1	832-107	IGNITION TRANSFORMER	GAS & COMB. 60 HZ
8	*2	848-36	CONNECTOR, BOX, 2 SCREW, 1/2"	—
9	*2	848-273	BOX, OUTLET, 4" SQ. X 2-1/8" DEEP	—
10	1	848-248	COVER, OUTLET BOX	—
11	1	848-10	CONNECTOR, SQUEEZE TYPE, 1/2" X 90°	—
12	8	868-137	CAPSCREW, HEX HD, 1/4"-20 X 1" LG.	—
13	*4	848-386	CONNECTOR, 3/4" COMPRESSION	—
14	*2	827-B	BULK CONDUIT, 1/2" x 12.75"	—
15	—	—	(NOT USED)	—
16	*4	848-100	BUSHING, ANTI-SHORT, 3/8"	—
17	2	848-31	CONNECTOR, BOX, 1/2" X 45°	—
18	1	848-16	CONNECTOR, SQUEEZE TYPE, 3/8" X 90°	ALL EXCEPT FUEL 700
19	2	848-3	CONNECTOR, BOX, 2 SCREW, 3/8"	—
20	*18	952-92	LOCKWASHER, 1/4"	—
21	4	860-7	MACH. SCR. RD. HD, 1/4"-20 X 1/2" LG.	—
22	4	952-94	LOCKWASHER, 1/2"	—
23	4	869-88	NUT, JAM, 1/2"-13	—
24	6	868-156	CAPSCREW, HEX HD, 1/4"-20 X 3/4" LG.	—
25	6	869-21	NUT, HEX, 1/4"-20	—
26	4	848-101	BUSHING, ANTI-SHORT, 1/2"	—
27	1	928-112	CLIP	—
28	1	841-148	SELF TAPPING SCREW, 10-32 x 1/2" LG	—
29	1	817-3446	HAWK ICS VSD	—
30	2	008-1736	BRACKET - CONTROL BOX	—

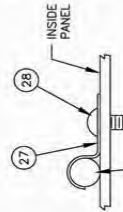
\* MAXIMUM QUANTITY SHOWN BASED ON REQUIREMENTS.

NOTES:  
 1. FOR FUEL 700 ONLY, ITEMS #6, 9, 13, 14, 16, 18, 19, 20, 24, 25, 26, 27, 28, 29, 30 ARE NOT REQUIRED ON FRONT HEAD AS SHOWN. USE 2 OF ITEM #11 AND PLUG HOLES WHERE ITEM #7 IS SHOWN.



DETAIL B

ITEM #29 ONLY REQ'D W/ HAWK ICS VSD



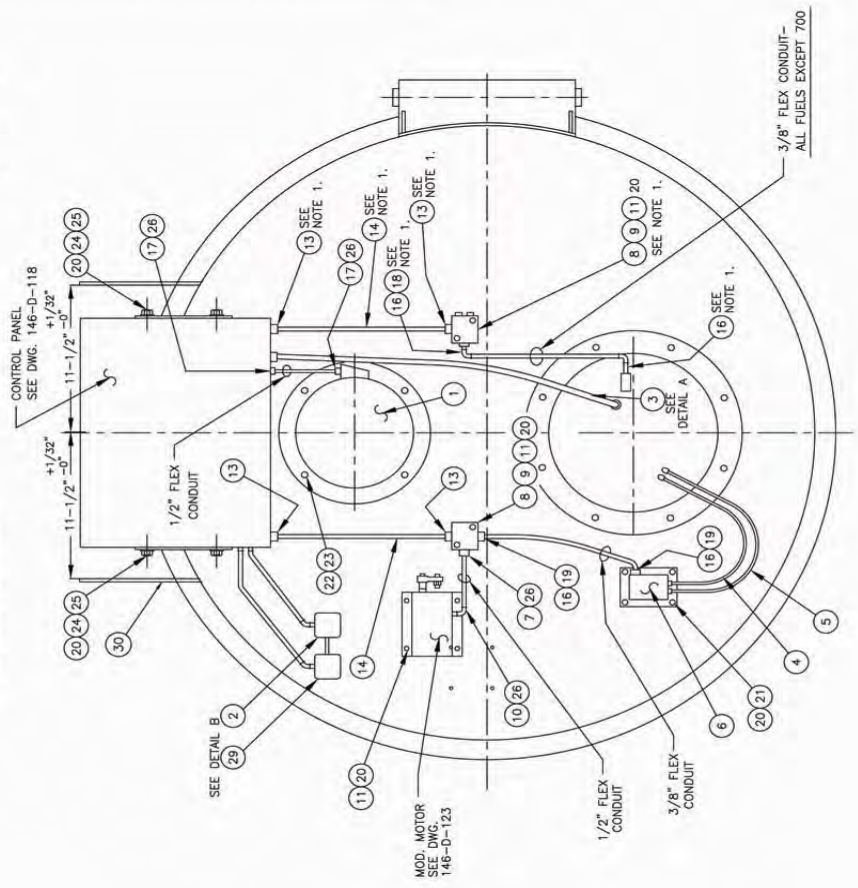
DETAIL A

MOUNT SCANNER CABLE INSIDE PANEL AND ENSURE A GOOD GROUND

BLOWER MOTOR ITEM (1)

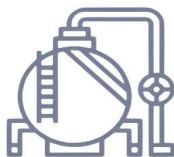
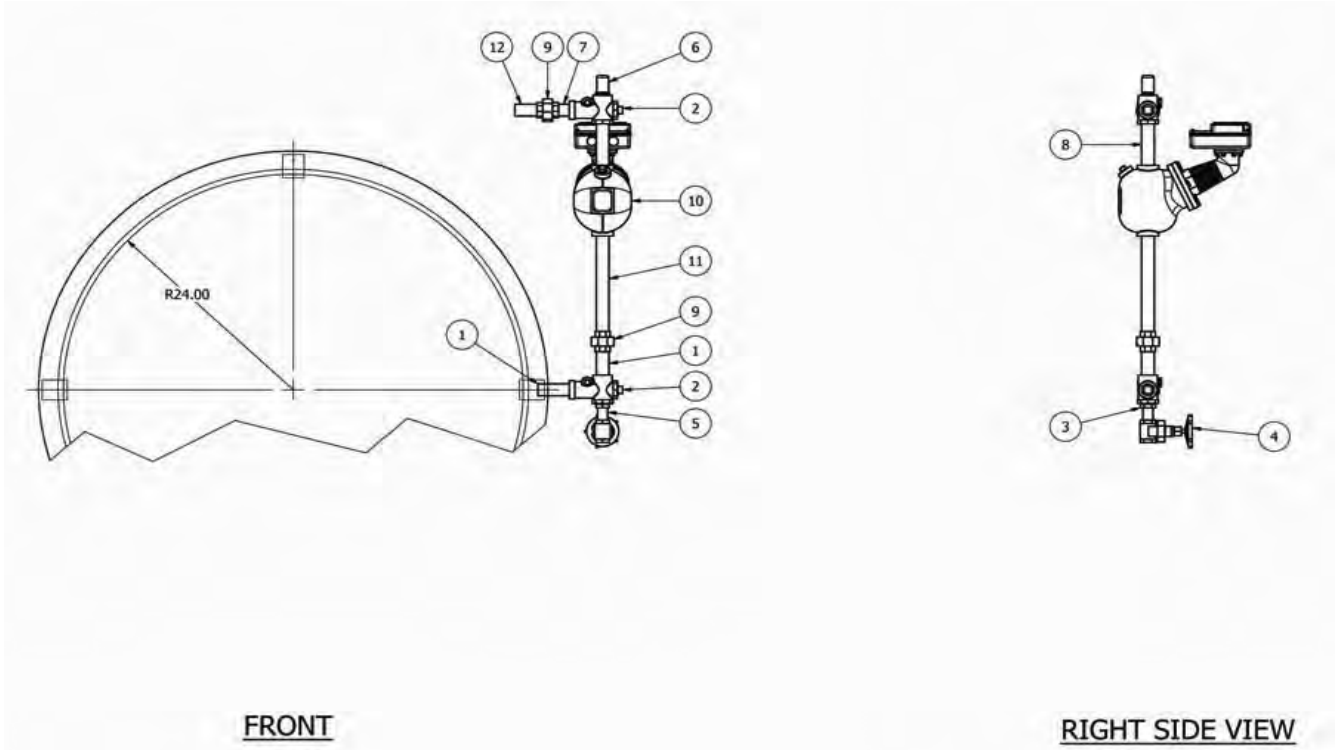
BOILER HP.	60 HZ.		50 HZ.	
	MOTOR H.P.	ODP	TEFC & HI-EFF.	ODP
50-80	ALL	2	894-2795   894-3426   894-2979	894-2797
100 100S & 125A	ALL	3	894-2799   894-2800   894-3393	894-2801

THIS MOTOR DOES NOT HAVE A 7/8" DIA. SHAFT IT IS 1-1/8" DIA. "IMPELLERS WILL HAVE TO BE REBored FOR PROPER INSTALLATION"



8.2.5 — LWCO Water Column Piping, 30 - 125# MDM

IT	QT	Part No.	Description	IT	QT	Part No.	Description
1	2	857-00644-000	NIPPLE, PIPE, SMLS, 1" NPS x 4", SCH.80	7	1	857-00751-000	NIPPLE, 1" SCH 80 X 2-1/2" LG. SA-106 GR. B
2	2	858-00259-000	PLUG, SQ. HEAD, 1" 300# FS	8	1	857-00645-000	NIPPLE, PIPE, SMLS, 1" NPS x 6", SCH.80
3	1	847-00469-000	BUSHING, HEX. HD.1" X 3/4" NPT F.S. ANSI B16.11	9	2	858-00166-000	UNION, 1" NPT 150# M.I.
4	1	941-00170-000	VALVE,GATE,BR, 3/4"TE,300#	10	1	817-02407-000	CONTROL,PUMP & LWCO,CB 150S-BM WITH C.B.LABEL
5	1	857-00746-000	NIPPLE,PIPE,SMLS 3/4" NPS X 2-1/2" SCH.80	11	1	857-01026-000	NIPPLE, PIPE, SMLS, 1" NPS x 12", SCH.80
6	1	941-02223-000	VALVE,TEST & CHECK,MCD-M TC4 SET	12	1	857-00639-000	NIPPLE, PIPE, SMLS, 1" NPS X 3" LG. SCH.80



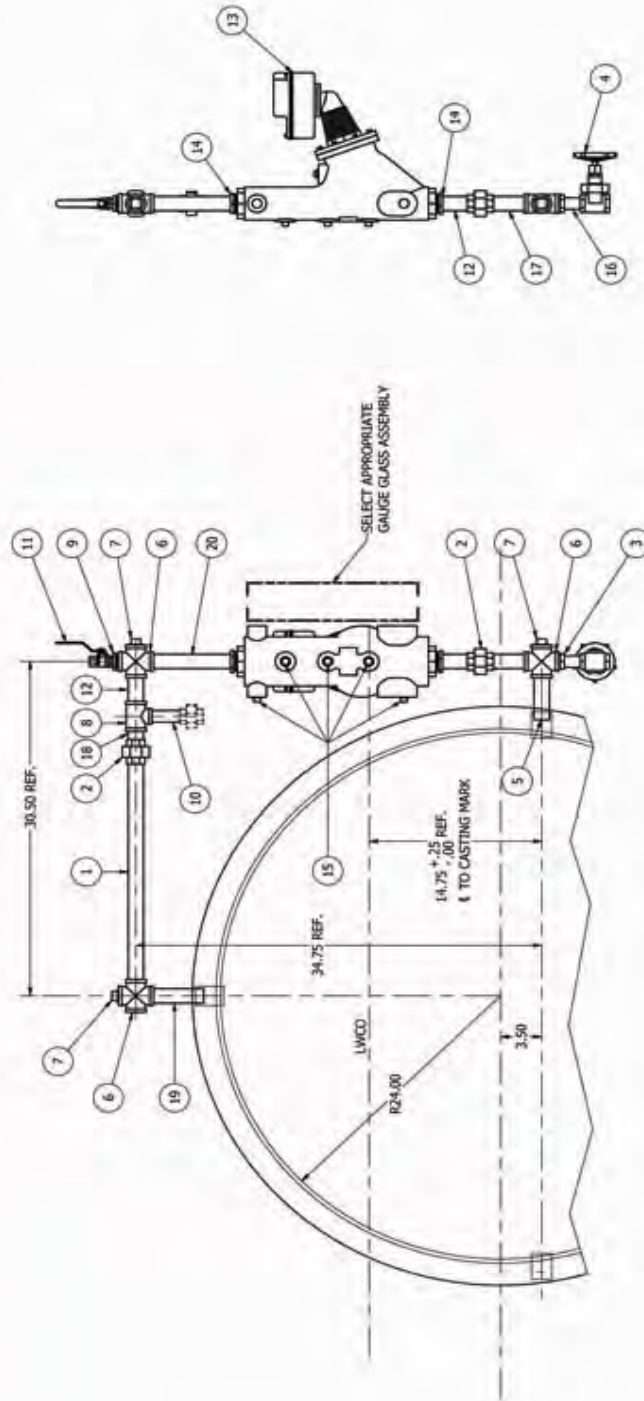
Courtesy of: **C3 Surplus LLC**  
**Surplus Industrial Superstore**  
 305-428-2777  
<https://www.c3surplus.com>

## 8.2.6 — LWCO Water Column Piping, 15# MDM

ITEM	QTY	Part No.	Description	ITEM	QTY	Part No.	Description
1	1	057-00657-000	SIZED PIPE, 1" SCH 80 SA-106 GR. B x 21" LG. T.B.E.	11	1	941-00055-000	VALVE, BALL, 1/4" NPT
2	2	858-00166-000	UNION, 1" NPT 150# M.L.	12	2	857-00753-000	NIPPLE, PIPE, SMLS, 1" NPS x 3-1/2", SCH.80
3	1	847-00469-000	BUSHING, HEX. HD, 1" X 3/4" NPT F.S., ANSI B16.11	13	1	817-02405-000	CONTROL PUMP & LWCO MDM 1575-RL
4	1	941-00170-000	VALVE GATE BR., 3/4" T.E. 300#	14	2	847-00472-000	BUSHING, HEX. HD, 1-1/4" X 1" NPT F.S., ANSI B16.11
5	1	857-00753-000	NIPPLE, PIPE, SMLS, 1" X 4-1/2" NPS, SCH.80	15	5	858-00266-000	PIPE PLUG, SQ. HD., 1/2" NPT, F.S., A-105
6	3	859-00264-000	CROSS, 1" NPT 150#	16	1	857-00746-000	NIPPLE/PIPE, SMLS 3/4" NPS X 2-1/2" SCH.80
7	3	858-00259-000	PLUG, SQ. HEAD, 1" 3000# FS	17	1	857-00664-000	NIPPLE, PIPE, SMLS, 1" NPS x 4", SCH.80
8	1	847-00280-000	TEE, REDUCING, 1" X 1" X 3/4" NPT, 150# M.L.	18	1	857-00751-000	NIPPLE, 1" SCH 80 X 2-1/2" LG. SA-106 GR. B
9	1	847-00467-000	BUSHING, REDUCING, 1" NPT, x 1/4" NPT	19	1	857-00640-000	NIPPLE/PIPE, SMLS, 1" NPS X 5' LG. SCH.80
10	1	857-00747-000	NIPPLE, PIPE, SMLS, 3/4" NPS x 3-1/2", SCH.80	20	1	857-00643-000	NIPPLE, PIPE, SMLS, 1" NPS x 8", SCH.80

NOTE: 1) OVERALL VERTICAL DIMENSION OF THE LWCO AND ALWCO ARE TO BE THE SAME. MAKE ADJUSTMENTS AS NECESSARY TO MAINTAIN MATCHING VERTICAL DIMENSIONS.

2) VERIFY PIPE LENGTHS NEEDED PRIOR TO CUTTING NON-STANDARD LENGTHS.



### 8.2.7 — LWCO Water Column Piping, 150# MDM

NOTE: 1) OVERALL VERTICAL DIMENSION OF THE LWCO AND ALWCO ARE TO BE THE SAME. MAKE ADJUSTMENTS AS NECESSARY TO MAINTAIN MATCHING VERTICAL DIMENSIONS.  
 2) VERIFY PIPE LENGTHS NEEDED PRIOR TO CUTTING NON-STANDARD LENGTHS.

ITEM	QTY	Part No.	Description	ITEM	QTY	Part No.	Description
1	2	858-00166-000	LWCO, 1" NPT 150# M.I.	11	1	857-00752-000	NIPPLE, PIPE, SMLS, 1" NPS x 3-1/2", SCH.80
2	1	847-00469-000	BUSHING, HEX. HD, 1" X 3/4" NPT F.S. ANSI B16.11	12	3	857-00640-000	NIPPLE, PIPE, SMLS, 1" NPS X 5" LG. SCH.80
3	1	941-01790-000	VALVE BALL BR., 750#MBF 200#	13	1	857-00645-000	NIPPLE, PIPE, SMLS, 1" NPS x 6", SCH.80
4	1	857-00753-000	NIPPLE, PIPE, SMLS, 1" X 4-1/2" NPS, SCH.80	14	5	858-00266-000	PIPE PLUG, SQ. HD., 1/2" NPT, F.S., A-105
5	2	859-00264-000	CROSS, 1" NPT 150#	15	1	817-04604-000	CONTROL PUMP & LWCO MCDM 193, 1" EQ. TAPPINGS
6	2	858-00259-000	PLUG, SQ. HEAD, 1" 3000# FS	16	1	900-00320-000	BULK PIPE, 1" SCH 80 SA-106 GR. B x 18" LG. T.B.E.
7	1	847-00467-000	TEE, REDUCING, 1" X 1" X 3/4" NPT, 150# M.I.	17	1	859-00264-000	CROSS, 1" NPT 150#
8	1	847-00467-000	BUSHING, REDUCING, 1" NPT. x 3/4" NPT	18	1	858-00259-000	PLUG, SQ. HEAD, 1" 3000# FS
9	1	857-00747-000	NIPPLE, PIPE, SMLS, 3/4" NPS x 3-1/2", SCH.80	19	1	857-00640-000	NIPPLE, PIPE, SMLS, 1" NPS X 5" LG. SCH.80
10	1	941-00055-000	VALVE BALL, 1/4" NPT				

30.50 REF.  
 34.75 REF.  
 18.1875 ±.25 REF. ↓ TO CASTING MARK  
 3.50  
 LWCO  
 R24.00  
 SELECT APPROPRIATE GAUGE GLASS ASSEMBLY

FRONT VIEW

RIGHT SIDE VIEW

### 8.2.8 — LWCO Water Column Piping, 15# Level Master

ITEM QTY	Part No.	Description	ITEM QTY	Part No.	Description
1	289-00235-000	WATER COLUMN, LEVEL MASTER, FOR FLANGED SENSOR	14	847-00789-000	TEE, REDUCING, 1" X 1" X 3/4" NPT, 150# M.I.
2	623-00177-000	LEVEL MASTER SENSOR PROBE	15	847-00467-000	BUSHING, REDUCING, 1" NPT. x 3/4" NPT
3	858-00166-000	UNION, 1" NPT 150# M.I.	16	857-00666-000	NIPPLE, PIPE, SCH.S, 3/4" NPS x 3", SCH.80
4	857-00751-000	NIPPLE, 1" SCH 80 X 2-1/2" LG. SA-106 GR. B	17	941-00055-000	VALVE BALL, 1/4" NPT
5	847-00469-000	BUSHING, HEX. HD. 1" X 3/4" NPT F.S. ANSI B16.11	18	857-00752-000	NIPPLE, PIPE, SCH.S, 1" NPS x 3-1/2", SCH.80
6	941-01790-000	VALVE BALL BR., .750" H&F, 200#	19	857-00659-000	NIPPLE, PIPE, SCH.S, 1/2" NPS x 8" LG., SCH.80
7	858-00164-000	UNION, 1/2" NPT 150# M.I.	20	900-00320-000	BULK PIPE, 1" SCH 80 SA-106 GR. B x 18" LG. T.B.E.
8	847-00279-000	TEE, REDUCING, 1" X 1" X 1/2" NPT 150# M.I.	21	857-00639-000	NIPPLE, PIPE, SCH.S, 1" NPS x 3" LG., SCH.80
9	859-00089-000	ELBOW, 90 DEG. 1/2" NPT 150# M.I.	22	857-00992-000	NIPPLE, PIPE, SCH.S, 1" NPS x 8", SCH.80
10	857-00740-000	NIPPLE, PIPE, SCH.S, 1/2" NPS x 1-1/2" LG., SCH.80	23	857-00640-000	NIPPLE/PIPE, SCH.S, 1" NPS x 5" LG. SCH.80
11	857-00753-000	NIPPLE, PIPE, SCH.S, 1" X 4-1/2" NPS, SCH.80	24	857-00649-000	NIPPLE, PIPE, SCH.S, 1/2" NPS x 4" LG., SCH.80
12	859-00264-000	CROSS, 1" NPT 150#	25	859-00264-000	CROSS, 1" NPT 150#
13	858-00259-000	PLUG, SQ. HEAD, 1" 3000# FS	26	858-00259-000	PLUG, SQ. HEAD, 1" 3000# FS

NOTE: 1) OVERALL VERTICAL DIMENSION OF THE LWCO AND ALWCO ARE TO BE THE SAME. MAKE ADJUSTMENTS AS NECESSARY TO MAINTAIN MATCHING VERTICAL DIMENSIONS.

2) VERIFY PIPE LENGTHS NEEDED PRIOR TO CUTTING NON-STANDARD LENGTHS.

FRONT VIEW

RIGHT SIDE VIEW

### 8.2.9 — LWCO Water Column Piping, 150# Level Master

ITEM	QTY	Part No.	Description	ITEM	QTY	Part No.	Description
1	1	289-00235-000	WATER COLUMN, LEVEL MASTER, FOR RANGED SENSOR	13	3	859-00264-000	CROSS, 1" NPT 150#
2	1	623-00172-000	LEVEL MASTER SENSOR PROBE	14	3	858-00259-000	PLUG, SQ. HEAD, 1" 3000# FS
3	1	057-03657-000	SIZED PIPE, 1" SCH 80 SA-106 GR. B x 21" LG. T.B.E.	15	1	847-00280-000	TEE, REDUCING, 1" X 1" X 3/4" NPT, 150# M.I.
4	2	858-00166-000	UNION, 1" NPT 150# M.I.	16	1	847-00467-000	BUSHING, REDUCING, 1" NPT. x 1/4" NPT
5	2	857-00751-000	NIPPLE, 1" SCH 80 X 2-1/2" LG. SA-106 GR. B	17	1	857-00651-000	NIPPLE, PIPE, SMLS, 1/2" NPS x 12" LG., SCH 80
6	1	847-00469-000	BUSHING, HEX. HD. 1" X 3/4" NPT F.S. ANSI B16.11	18	1	857-00747-000	NIPPLE, PIPE, SMLS, 3/4" NPS x 3-1/2", SCH 80
7	1	941-00190-000	VALVE BALL GR., .750" NPT, 200#	19	1	941-00055-000	VALVE BALL, 1/4" NPT
8	1	858-00164-000	UNION, 1/2" NPT 150# M.I.	20	1	857-00752-000	NIPPLE, PIPE, SMLS, 1" NPS x 3-1/2", SCH 80
9	1	847-00279-000	TEE, REDUCING, 1" X 1" X 1/2" NPT 150# M.I.	21	2	857-00640-000	NIPPLE, PIPE, SMLS, 1" NPS x 5" LG. SCH 80
10	1	859-00980-000	ELBOW, 90 DEG. 1/2" NPT 150# M.I.	22	2	857-00645-000	NIPPLE, PIPE, SMLS, 1" NPS x 6", SCH 80
11	1	857-00740-000	NIPPLE, PIPE, SMLS, 1/2" NPS x 1-1/2" LG., SCH 80	23	1	857-00675-000	NIPPLE, 1/2" SCH. 80 X 3" LG. SA-106 GR. B
12	1	857-00753-000	NIPPLE, PIPE, SMLS, 1" X 4-1/2" NPS, SCH 80				

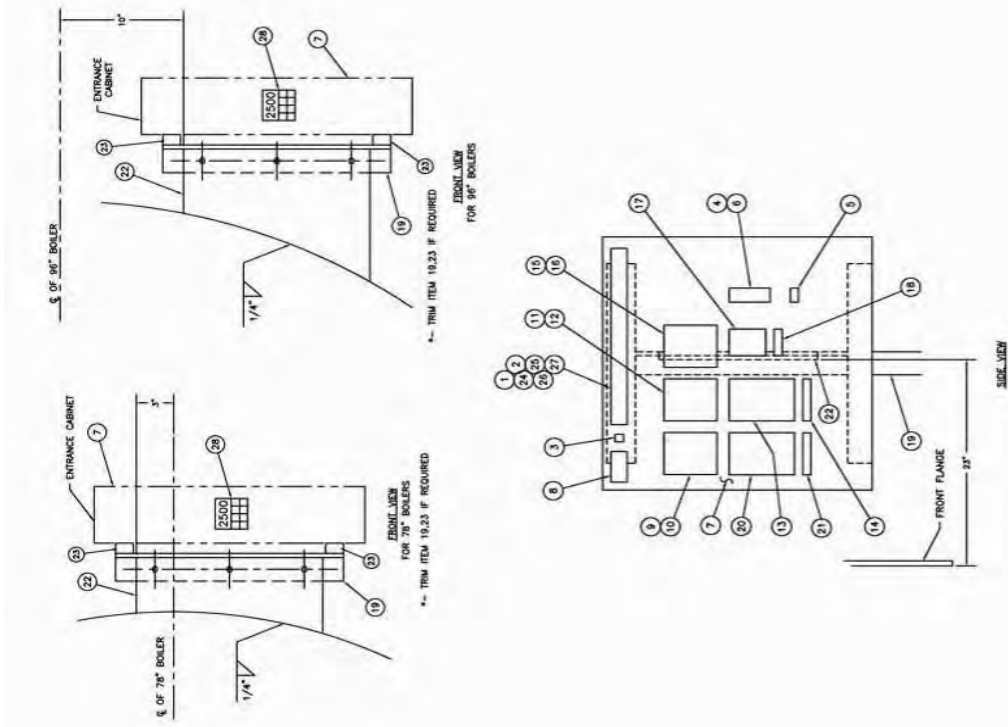
NOTE: 1) OVERALL VERTICAL DIMENSION OF THE LWCO AND ALWCO ARE TO BE THE SAME. MAKE ADJUSTMENTS AS NECESSARY TO MAINTAIN MATCHING VERTICAL DIMENSIONS.

2) VERIFY PIPE LENGTHS NEEDED PRIOR TO CUTTING NON-STANDARD LENGTHS.

**FRONT VIEW**

**RIGHT SIDE VIEW**

### 8.2.10 — Entrance Box



ITEM	QTY	PART NO.	DESCRIPTION	BOTH PLANTS	USED ON	TRM. ONLY	CANADA ONLY	OPTION
1	**	832-2326	TERMINAL LUG	ALL				-
2	1	116-1665	PLATE, LD. FOR TRM. STRIP	ALL				CS
3	1	894-78	GROUND LUG	ALL				CS
4	1	146-358	FUSE BLOCK, CONTROL CIRCUIT	ALL				CS
5	1	146-358	FUSE CONTROL CIRCUIT	ALL				D,192
6	1	848-1083	FUEL 700 (48" - 87")					CS
7	1	848-328	ENT. BOX (18 X 15 X 6) (PULL BOX)		FUEL 100, 101, 200 ON 78"/94" CBW & 700 ON 85"-108" L7/W			CS
8	1	848-328	ENT. BOX (24 X 24 X 6) (PULL BOX)		FUEL 400 & 600 ON 78" CBW			CS
9	1	848-1091	ENT. BOX (30 X 24 X 6) (PULL BOX)		FUEL 100, 101, 200, 400 & 600 ON 85"-108" L7/W			CS
10	1	SEE TABLE BELOW	MAIN POWER TERMINAL BLOCK		DETERMINED BY TOTAL AMP. LOAD			CS
11	1	146-358.537	BLOWER MOTOR FUSE	VARIES				CS
12	1	146-358.537	HEATER FUSE	VARIES				CS
13	1	146-358.537	COMPRESSOR MOTOR FUSE	VARIES				CS
14	1	146-358.537	AIR COMPRESSOR MOTOR FUSE BLOCK	VARIES				CS
15	1	118-1867	AIR COMPRESSOR MOTOR STARTER	W/ ITEMS 11, 12, & 13				CS
16	1	146-358.537	OIL HEATER FUSE	VARIES				CS
17	1	146-357	OIL HEATER CONTACTOR	VARIES				CS
18	1	833-2197	OIL HEATER EMBLEM	W/ ITEMS 15 & 16				CS
19	1	848-328	ENT. BOX (18 X 15 X 6) (PULL BOX)	W/ ITEMS 15, 16, & 17				CS
20	1	848-328	ENT. BOX (24 X 24 X 6) (PULL BOX)	ALL UNITS EXCEPT 700				CS
21	1	848-328	ENT. BOX (30 X 24 X 6) (PULL BOX)	48" FUEL 700				CS
22	1	848-328	ENT. BOX (30 X 24 X 6) (PULL BOX)					CS
23	1	848-328	ENT. BOX (30 X 24 X 6) (PULL BOX)					CS
24	1	N/A						CS
25	2	832-2248	RETAINING CLIP	ALL				CS
26	**	832-1951	CHANNEL	ALL				CS
27	**	832-2248	WARNING STRIP	ALL				CS
28	1	832-2248	WARNING STRIP	ALL				CS
29	1	832-2248	WARNING STRIP	ALL				CS
30	1	832-2248	WARNING STRIP	ALL				CS
31	1	832-2248	WARNING STRIP	ALL				CS
32	1	832-2248	WARNING STRIP	ALL				CS
33	1	832-2248	WARNING STRIP	ALL				CS
34	1	832-2248	WARNING STRIP	ALL				CS
35	1	832-2248	WARNING STRIP	ALL				CS
36	1	832-2248	WARNING STRIP	ALL				CS
37	1	832-2248	WARNING STRIP	ALL				CS
38	1	832-2248	WARNING STRIP	ALL				CS
39	1	832-2248	WARNING STRIP	ALL				CS
40	1	832-2248	WARNING STRIP	ALL				CS
41	1	832-2248	WARNING STRIP	ALL				CS
42	1	832-2248	WARNING STRIP	ALL				CS
43	1	832-2248	WARNING STRIP	ALL				CS
44	1	832-2248	WARNING STRIP	ALL				CS
45	1	832-2248	WARNING STRIP	ALL				CS
46	1	832-2248	WARNING STRIP	ALL				CS
47	1	832-2248	WARNING STRIP	ALL				CS
48	1	832-2248	WARNING STRIP	ALL				CS
49	1	832-2248	WARNING STRIP	ALL				CS
50	1	832-2248	WARNING STRIP	ALL				CS

MAIN POWER TERMINAL BLOCK PART NO.'S

AMPS	TRM. NO.
30	832-780
70	832-781
150	832-782
250	832-783
300	832-1902

NOTE:  
 \* QTY 1 ON VOLTAGE 2340.  
 \*\* QTY 15 AS REQ'D.  
 1. PULL BOX, 18" AND 18" WIDE CABINETS  
 2. PULL BOX, 24" WIDE CABINETS  
 3. PULL BOX, 24" WIDE CABINETS  
 4. PULL BOX, 24" WIDE CABINETS  
 5. PULL BOX, 24" WIDE CABINETS  
 6. PULL BOX, 24" WIDE CABINETS  
 7. PULL BOX, 24" WIDE CABINETS  
 8. PULL BOX, 24" WIDE CABINETS  
 9. PULL BOX, 24" WIDE CABINETS  
 10. PULL BOX, 24" WIDE CABINETS  
 11. PULL BOX, 24" WIDE CABINETS  
 12. PULL BOX, 24" WIDE CABINETS  
 13. PULL BOX, 24" WIDE CABINETS  
 14. PULL BOX, 24" WIDE CABINETS  
 15. PULL BOX, 24" WIDE CABINETS  
 16. PULL BOX, 24" WIDE CABINETS  
 17. PULL BOX, 24" WIDE CABINETS  
 18. PULL BOX, 24" WIDE CABINETS  
 19. PULL BOX, 24" WIDE CABINETS  
 20. PULL BOX, 24" WIDE CABINETS  
 21. PULL BOX, 24" WIDE CABINETS  
 22. PULL BOX, 24" WIDE CABINETS  
 23. PULL BOX, 24" WIDE CABINETS  
 24. PULL BOX, 24" WIDE CABINETS  
 25. PULL BOX, 24" WIDE CABINETS  
 26. PULL BOX, 24" WIDE CABINETS  
 27. PULL BOX, 24" WIDE CABINETS  
 28. PULL BOX, 24" WIDE CABINETS  
 29. PULL BOX, 24" WIDE CABINETS  
 30. PULL BOX, 24" WIDE CABINETS  
 31. PULL BOX, 24" WIDE CABINETS  
 32. PULL BOX, 24" WIDE CABINETS  
 33. PULL BOX, 24" WIDE CABINETS  
 34. PULL BOX, 24" WIDE CABINETS  
 35. PULL BOX, 24" WIDE CABINETS  
 36. PULL BOX, 24" WIDE CABINETS  
 37. PULL BOX, 24" WIDE CABINETS  
 38. PULL BOX, 24" WIDE CABINETS  
 39. PULL BOX, 24" WIDE CABINETS  
 40. PULL BOX, 24" WIDE CABINETS  
 41. PULL BOX, 24" WIDE CABINETS  
 42. PULL BOX, 24" WIDE CABINETS  
 43. PULL BOX, 24" WIDE CABINETS  
 44. PULL BOX, 24" WIDE CABINETS  
 45. PULL BOX, 24" WIDE CABINETS  
 46. PULL BOX, 24" WIDE CABINETS  
 47. PULL BOX, 24" WIDE CABINETS  
 48. PULL BOX, 24" WIDE CABINETS  
 49. PULL BOX, 24" WIDE CABINETS  
 50. PULL BOX, 24" WIDE CABINETS



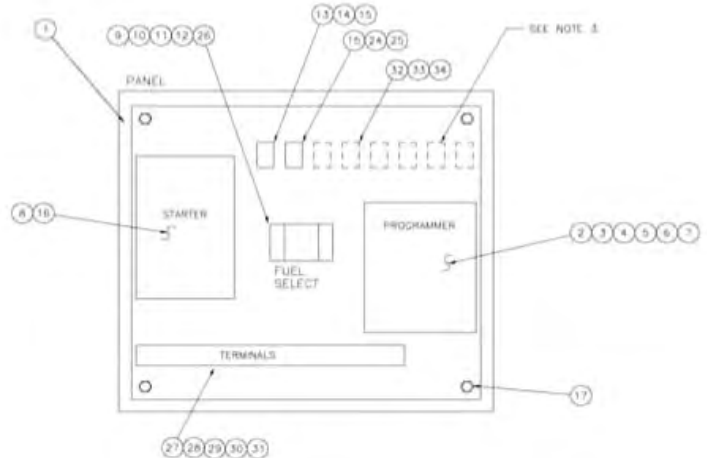
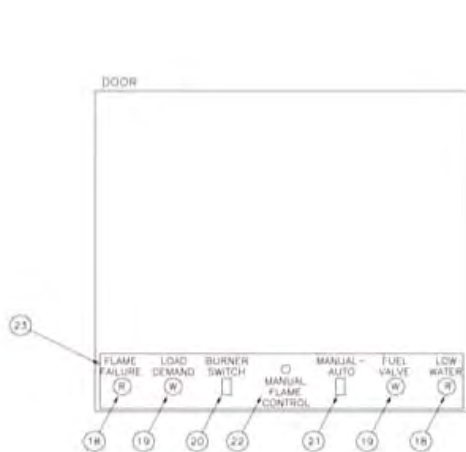
### 8.2.11 — Control Panel

ITEM		TABLE 1 FUEL SERIES					
		100	101	200	400	600	700
4	CB120 (00)	833-3139		833-3708**	833-3138	833-3708**	
	BURNER LOGX (05)	833-3138		833-3709**	833-3138	833-3709**	
11				8-801	8-3228	8-801	

FLAME SAFEGARD ITEM		TABLE 2					
		2	3	4	5*	6	7*
		BASE	DISPLAY	CHASSIS	AMP. (R)	MODULE	FD (R)
CB78DL (04)		833-2725	833-2727	833-3517	833-5495		817-4133
CB120 (00)		833-3135	833-3151	SEE TABLE 1	N/A	833-3143	817-2261
BURNER LOGX (05)		833-3152	833-3150	SEE TABLE 1	N/A	833-3142	817-1933

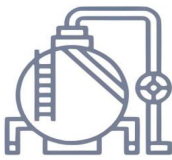
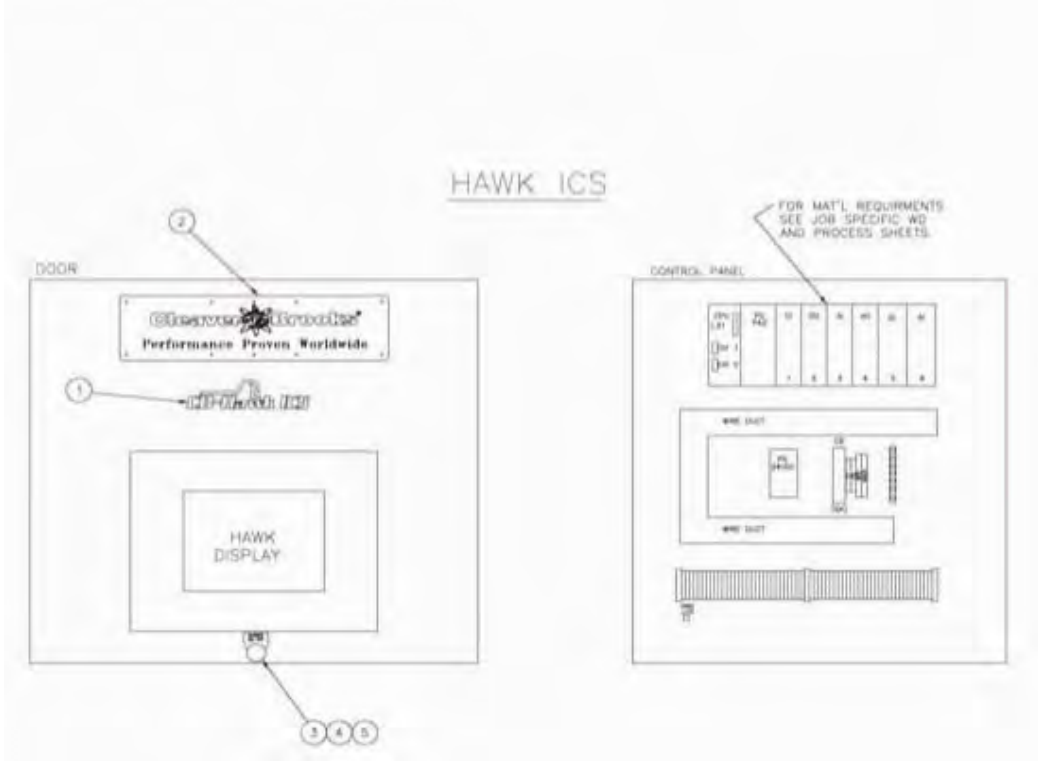
- NOTES: 1. STARTERS SIZE 8 AND LARGER ARE IN OWN ENCLOSURE MOUNTED ON THE FRONT HEAD. SEE REFERENCE DWG. 146-C-12).
2. OVERLOADS ARE TO BE SUPPLIED BASED ON MOTOR NAMEPLATE AMP. RATING.
3. MAXIMUM QUANTITY OF RELAYS, TIMERS, OR COMBINATION OF BOTH IS 8.
4. USE UV SCANNER ON BOILERS WITH NTI BURNERS FIRING GAS AS THE PRIMARY FUEL AS SHOWN BELOW.
- CB78DL: USE 833-2724 UV AMPLIFIER & 817-1743 UV SCANNER  
 CB120: USE 817-2262 UV SCANNER  
 BURNER LOGX: USE 833-2262 UV SCANNER
5. USE 833-3138 OR 833-3139 FOR APPLICATIONS WITHOUT EGR.

CONTROL CABINET (NON-HAWK)					
ITEM	QTY	PART NO.	DESCRIPTION	USED ON	OPTION
1	1	119-405	CONTROL CABINET (W/SUB BASE)	78"-106"	D3
2	1	119-814		48"-67"	
3	1		PROGRAMMER-BASE		
4	1		PROGRAMMER-DISPLAY		SEE TABLE 3
5	1		PROGRAMMER-CHASSIS		
6	1		PROGRAMMER-AMPLIFIER		
7	1		PROGRAMMER-MODULE		
8	1		PROGRAMMER-FLAME DETECTOR		
8	1	148-355,377	STARTER (SEE NOTE 1 & 2)		D3
9	1	836-74E	SWITCH,GAS-OIL	FUEL 200,400	D3
10	1	118-198	NAMEPLATE,GAS-OIL	FUEL 200,400	D3
11	1	SEE TABLE 1	BRACKET		D3
12	1	836-70B	SWITCH,OIL HEATER	FUEL 400,600	D3
13	1	833-2261	RELAY	FUEL 200,400	D3
14	1	833-2263	BASE	FUEL 200,400	D3
15	2	841-1463	SCREW, SELF-TAPPING	WITH ITEM 14,25	
16	3	841-801	SCREW, SELF-TAPPING	WITH ITEM 8	
17	4	841-89	NUT, SELF-LOCKING		
18	2	881-388	LIGHT ASSEMBLY, RED LENS		D3
19	2	881-387	LIGHT ASSEMBLY, WHITE LENS		D3
20	1	836-70B	SWITCH, BURNER		D3
21	1	836-217	SWITCH, MANUAL - AUTO		D3
22	1	836-209	SWITCH, MANUAL FLAME CONTROL		D3
23	1	118-1689	NAMEPLATE		D3
24	1	833-2261	RELAY (AIR PURGE)	FUEL 400,600	D3
25	1	833-2263	BASE (AIR PURGE)	FUEL 400,600	D3
26	1	118-204	NAMEPLATE-OIL HEATER	FUEL 400,600	D3
27	38	832-232B	TERMINAL,LUG		
28		N/A			
29	2	832-2248	RETAINING CLIP		
30	18*	832-1951	CHANNEL		
31	1	832-2246	MARKING STRIP		
32	1	833-2377	RELAY, 24VAC, GOLD FLASHED	150# H.T.H.W.	D3
33	1	833-2378	BASE	150# H.T.H.W.	D3
34	1	840-238	RESISTOR KIT, 8-20MA - 135OHM	150# H.T.H.W.	D3



Courtesy of: **C3 Surplus LLC**  
**Surplus Industrial Superstore**  
 305-428-2777  
<https://www.c3surplus.com>

CONTROL CABINET (HAWK ICS)				
ITEM	QTY	PART NO.	DESCRIPTION	OPTION
1	1	118-2462	LABEL CB HAWK ICS	C3
2	1	118-3173	LABEL CLEAVER BROOKS	C3
3	1	836-620	CONTACT	
4	1	836-623	SWITCH	
5	1	118-1382	NAMEPLATE	

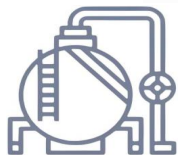
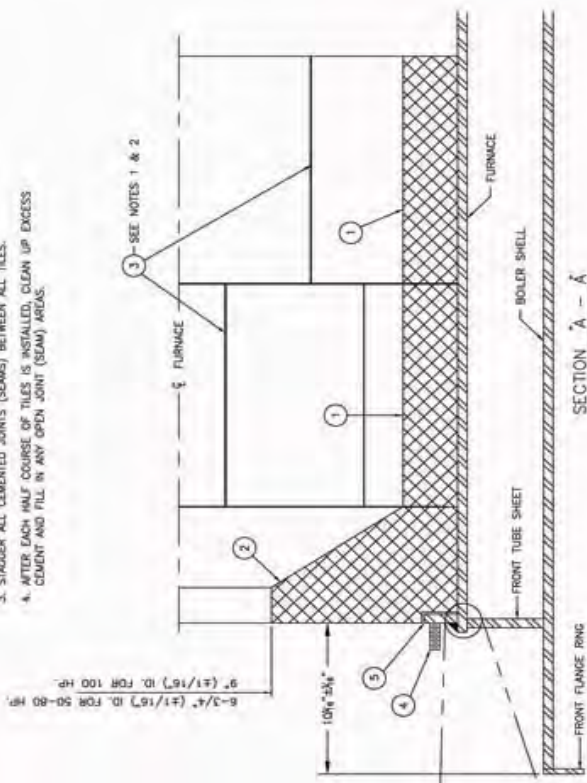
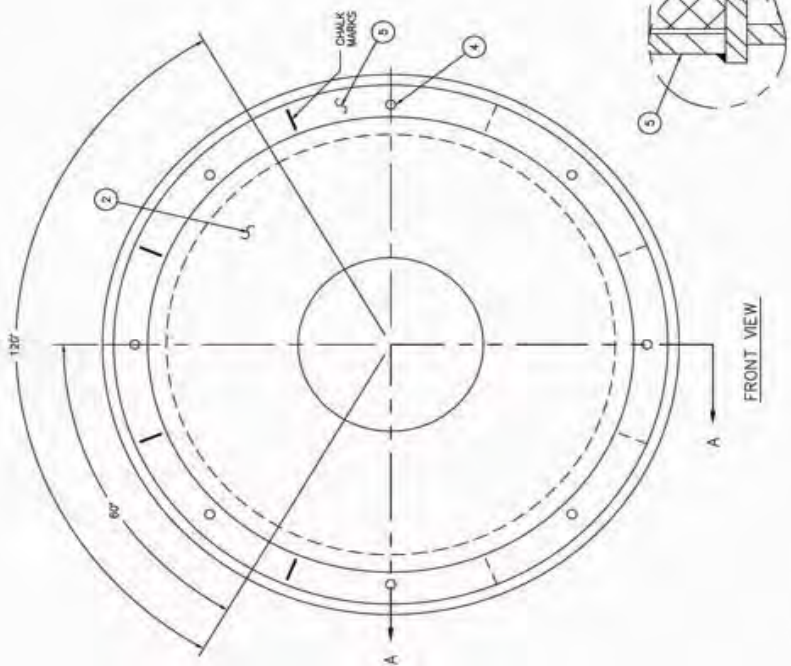


Courtesy of: **C3 Surplus LLC**  
**Surplus Industrial Superstore**  
**305-428-2777**  
<https://www.c3surplus.com>

### 8.2.12 — Furnace Liner & Bricking

ITEM	QTY	PART NO.	DESCRIPTION	USED ON	OPTION
1	16	84-A-216	REFRACTORY TILE, FURNACE		
		324-B-392	TILEBURNER THROAT	CB50-80	A3
		324-C-393		CB100-125A D-300P5	
2	1	324-442	TILEBURNER THROAT	CB100, 350P5	
		324-450		CB50-80, 300P5	
3	1#	872-28	CEMENT, JOINT MORTAR, FIBREX SUPERKOTE		
4	8	841-1885	STUD, MACH. 3/8-16 X 1-1/2" LG.		
		80-A-418	RING, FURNACE FLANGE	CB50 & 80 @ 15-150# HW, ALL 1/8" ST. & 30# HW.	
5	1	80-508	RING, FURNACE FLANGE DWG 80-A-418	CB70-125A @ 125# HW, CB 70-125A 150# HW, CB 70-100S 150-200#ST, CB 50-80 200-250#ST.	
		80-773	RING, FURNACE FLANGE DWG 80-A-418	CB 70-100S 250#ST, CB 50-100S 300#ST.	A3
		80-507	RING, FURNACE FLANGE DWG 80-A-418	ALL 350# ST.	
		80-338	RING, FURNACE FLANGE DWG 80-A-338	48" W/ CORR FURN	

- NOTES:
- NO CUT TILES TO BE INSTALLED IN UPPER 120° QUADRANT OF FURNACE OR DRY OVEN.
  - PACK ALL TILES TIGHTLY W/ MALET AND REMOVE ALL EXCESS CEMENT - 1/16" TYPICAL JOINT / 1/8" MAX. ONLY APPLIED BETWEEN TILES AND BRICKS. ALL TILES AND BRICKS SHOULD FIT TIGHT TO FURNACE OR DRY OVEN WALLS W/ NO EXPANSION SPACE BETWEEN.
  - STAGGER ALL CEMENTED JOINTS (SEAMS) BETWEEN ALL TILES.
  - AFTER EACH HALF COURSE OF TILES IS INSTALLED, CLEAN UP EXCESS CEMENT AND FILL IN ANY OPEN JOINT (SEAM) AREAS.



Courtesy of: **C3 Surplus LLC**  
**Surplus Industrial Superstore**  
 305-428-2777  
<https://www.c3surplus.com>

### 8.2.13 — Front Head Linkage

48" DIA. BOILER					
QTY	QUANTITY GAS OR LIQ	PART NO.	DESCRIPTION	REF. USED	OPTION
1	1	211-13-5	LINK ASSEMBLY	BM/AA	
1	1	211-13-6	LINK ASSEMBLY	BM/AA	
1	1	211-13-7	LINK ASSEMBLY	BM/AA	
1	1	211-13-8	LINK ASSEMBLY	BM/AA	
1	1	211-13-9	LINK ASSEMBLY	BM/AA	
1	1	211-13-10	LINK ASSEMBLY	BM/AA	
1	1	211-13-11	LINK ASSEMBLY	BM/AA	
1	1	211-13-12	LINK ASSEMBLY	BM/AA	
1	1	211-13-13	LINK ASSEMBLY	BM/AA	
1	1	211-13-14	LINK ASSEMBLY	BM/AA	
1	1	211-13-15	LINK ASSEMBLY	BM/AA	
1	1	211-13-16	LINK ASSEMBLY	BM/AA	
1	1	211-13-17	LINK ASSEMBLY	BM/AA	
1	1	211-13-18	LINK ASSEMBLY	BM/AA	
1	1	211-13-19	LINK ASSEMBLY	BM/AA	
1	1	211-13-20	LINK ASSEMBLY	BM/AA	
1	1	211-13-21	LINK ASSEMBLY	BM/AA	
1	1	211-13-22	LINK ASSEMBLY	BM/AA	
1	1	211-13-23	LINK ASSEMBLY	BM/AA	
1	1	211-13-24	LINK ASSEMBLY	BM/AA	
1	1	211-13-25	LINK ASSEMBLY	BM/AA	
1	1	211-13-26	LINK ASSEMBLY	BM/AA	
1	1	211-13-27	LINK ASSEMBLY	BM/AA	
1	1	211-13-28	LINK ASSEMBLY	BM/AA	
1	1	211-13-29	LINK ASSEMBLY	BM/AA	
1	1	211-13-30	LINK ASSEMBLY	BM/AA	
1	1	211-13-31	LINK ASSEMBLY	BM/AA	
1	1	211-13-32	LINK ASSEMBLY	BM/AA	
1	1	211-13-33	LINK ASSEMBLY	BM/AA	
1	1	211-13-34	LINK ASSEMBLY	BM/AA	
1	1	211-13-35	LINK ASSEMBLY	BM/AA	
1	1	211-13-36	LINK ASSEMBLY	BM/AA	
1	1	211-13-37	LINK ASSEMBLY	BM/AA	
1	1	211-13-38	LINK ASSEMBLY	BM/AA	
1	1	211-13-39	LINK ASSEMBLY	BM/AA	
1	1	211-13-40	LINK ASSEMBLY	BM/AA	
1	1	211-13-41	LINK ASSEMBLY	BM/AA	
1	1	211-13-42	LINK ASSEMBLY	BM/AA	
1	1	211-13-43	LINK ASSEMBLY	BM/AA	
1	1	211-13-44	LINK ASSEMBLY	BM/AA	
1	1	211-13-45	LINK ASSEMBLY	BM/AA	
1	1	211-13-46	LINK ASSEMBLY	BM/AA	
1	1	211-13-47	LINK ASSEMBLY	BM/AA	
1	1	211-13-48	LINK ASSEMBLY	BM/AA	
1	1	211-13-49	LINK ASSEMBLY	BM/AA	
1	1	211-13-50	LINK ASSEMBLY	BM/AA	
1	1	211-13-51	LINK ASSEMBLY	BM/AA	
1	1	211-13-52	LINK ASSEMBLY	BM/AA	
1	1	211-13-53	LINK ASSEMBLY	BM/AA	
1	1	211-13-54	LINK ASSEMBLY	BM/AA	
1	1	211-13-55	LINK ASSEMBLY	BM/AA	
1	1	211-13-56	LINK ASSEMBLY	BM/AA	
1	1	211-13-57	LINK ASSEMBLY	BM/AA	
1	1	211-13-58	LINK ASSEMBLY	BM/AA	
1	1	211-13-59	LINK ASSEMBLY	BM/AA	
1	1	211-13-60	LINK ASSEMBLY	BM/AA	
1	1	211-13-61	LINK ASSEMBLY	BM/AA	
1	1	211-13-62	LINK ASSEMBLY	BM/AA	
1	1	211-13-63	LINK ASSEMBLY	BM/AA	
1	1	211-13-64	LINK ASSEMBLY	BM/AA	
1	1	211-13-65	LINK ASSEMBLY	BM/AA	
1	1	211-13-66	LINK ASSEMBLY	BM/AA	
1	1	211-13-67	LINK ASSEMBLY	BM/AA	
1	1	211-13-68	LINK ASSEMBLY	BM/AA	
1	1	211-13-69	LINK ASSEMBLY	BM/AA	
1	1	211-13-70	LINK ASSEMBLY	BM/AA	
1	1	211-13-71	LINK ASSEMBLY	BM/AA	
1	1	211-13-72	LINK ASSEMBLY	BM/AA	
1	1	211-13-73	LINK ASSEMBLY	BM/AA	
1	1	211-13-74	LINK ASSEMBLY	BM/AA	
1	1	211-13-75	LINK ASSEMBLY	BM/AA	
1	1	211-13-76	LINK ASSEMBLY	BM/AA	
1	1	211-13-77	LINK ASSEMBLY	BM/AA	
1	1	211-13-78	LINK ASSEMBLY	BM/AA	
1	1	211-13-79	LINK ASSEMBLY	BM/AA	
1	1	211-13-80	LINK ASSEMBLY	BM/AA	
1	1	211-13-81	LINK ASSEMBLY	BM/AA	
1	1	211-13-82	LINK ASSEMBLY	BM/AA	
1	1	211-13-83	LINK ASSEMBLY	BM/AA	
1	1	211-13-84	LINK ASSEMBLY	BM/AA	
1	1	211-13-85	LINK ASSEMBLY	BM/AA	
1	1	211-13-86	LINK ASSEMBLY	BM/AA	
1	1	211-13-87	LINK ASSEMBLY	BM/AA	
1	1	211-13-88	LINK ASSEMBLY	BM/AA	
1	1	211-13-89	LINK ASSEMBLY	BM/AA	
1	1	211-13-90	LINK ASSEMBLY	BM/AA	
1	1	211-13-91	LINK ASSEMBLY	BM/AA	
1	1	211-13-92	LINK ASSEMBLY	BM/AA	
1	1	211-13-93	LINK ASSEMBLY	BM/AA	
1	1	211-13-94	LINK ASSEMBLY	BM/AA	
1	1	211-13-95	LINK ASSEMBLY	BM/AA	
1	1	211-13-96	LINK ASSEMBLY	BM/AA	
1	1	211-13-97	LINK ASSEMBLY	BM/AA	
1	1	211-13-98	LINK ASSEMBLY	BM/AA	
1	1	211-13-99	LINK ASSEMBLY	BM/AA	
1	1	211-13-100	LINK ASSEMBLY	BM/AA	

FRONT VIEW

RIGHT SIDE VIEW

DETAIL 1-1

DETAIL 2-2

FRONT HEAD ASSEMBLY

SEE NOTE 3

SEE NOTE 4

SEE NOTE 5

SEE NOTE 6

SEE NOTE 7

SEE NOTE 8

SEE NOTE 9

SEE NOTE 10

SEE NOTE 11

SEE NOTE 12

SEE NOTE 13

SEE NOTE 14

SEE NOTE 15

SEE NOTE 16

SEE NOTE 17

SEE NOTE 18

SEE NOTE 19

SEE NOTE 20

SEE NOTE 21

SEE NOTE 22

SEE NOTE 23

SEE NOTE 24

SEE NOTE 25

SEE NOTE 26

SEE NOTE 27

SEE NOTE 28

SEE NOTE 29

SEE NOTE 30

SEE NOTE 31

SEE NOTE 32

SEE NOTE 33

SEE NOTE 34

SEE NOTE 35

SEE NOTE 36

SEE NOTE 37

SEE NOTE 38

SEE NOTE 39

SEE NOTE 40

SEE NOTE 41

SEE NOTE 42

SEE NOTE 43

SEE NOTE 44

SEE NOTE 45

SEE NOTE 46

SEE NOTE 47

SEE NOTE 48

SEE NOTE 49

SEE NOTE 50

SEE NOTE 51

SEE NOTE 52

SEE NOTE 53

SEE NOTE 54

SEE NOTE 55

SEE NOTE 56

SEE NOTE 57

SEE NOTE 58

SEE NOTE 59

SEE NOTE 60

SEE NOTE 61

SEE NOTE 62

SEE NOTE 63

SEE NOTE 64

SEE NOTE 65

SEE NOTE 66

SEE NOTE 67

SEE NOTE 68

SEE NOTE 69

SEE NOTE 70

SEE NOTE 71

SEE NOTE 72

SEE NOTE 73

SEE NOTE 74

SEE NOTE 75

SEE NOTE 76

SEE NOTE 77

SEE NOTE 78

SEE NOTE 79

SEE NOTE 80

SEE NOTE 81

SEE NOTE 82

SEE NOTE 83

SEE NOTE 84

SEE NOTE 85

SEE NOTE 86

SEE NOTE 87

SEE NOTE 88

SEE NOTE 89

SEE NOTE 90

SEE NOTE 91

SEE NOTE 92

SEE NOTE 93

SEE NOTE 94

SEE NOTE 95

SEE NOTE 96

SEE NOTE 97

SEE NOTE 98

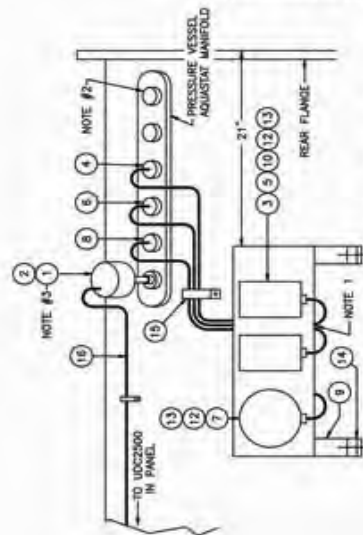
SEE NOTE 99

SEE NOTE 100

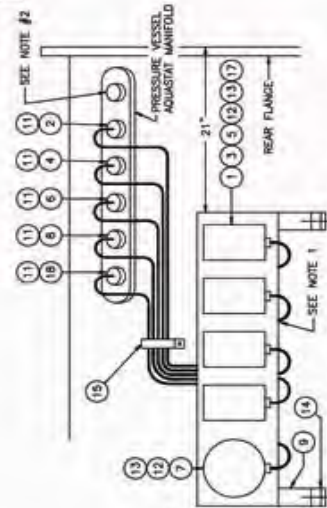
### 8.2.14 — Temperature Controls

CB780/CB100/E100 281-360 DEG F. HTHW		CB780/CB100/E100 240-280 DEG F. HTHW		CB780/CB100/E100 170-240 DEG F.		BILL OF MATERIAL	
ITEM	QTY	PKMT NO.	DESCRIPTION	ITEM	QTY	PKMT NO.	DESCRIPTION
1	1	832-2001 **	SEE TABLE	1	1	817-1244	TEMPERATURE CONTROL, MODULATING (MC)
2	1	937-772	SEE TABLE	2	1	817-378	WELL, SEPARABLE
3	1	817-4289	SEE TABLE	3	1	817-2402	TEMPERATURE CONTROL, HIGH LIMIT (HLC)
4	1	817-699	SEE TABLE	4	1	817-399 ①②	WELL, SEPARABLE
5	1	817-492	SEE TABLE	5	1	817-400	TEMPERATURE CONTROL, OPERATING LIMIT (OLC)
6	1	817-698	SEE TABLE	6	1	817-398 ①②	WELL, SEPARABLE
7	1	937-710	SEE TABLE	7	1	937-797	THERMOMETER
8	1	937-673	SEE TABLE	8	1	937-27	THERMOMETER
9	1	937-658	SEE TABLE	9	1	817-3103	WELL, SEPARABLE
10	2	008-995	SEE TABLE	10	2	008-995	SEE TABLE
11	1	008-995	SEE TABLE	11	1	008-1317	SEE TABLE
12	9	860-4	SEE TABLE	12	9	860-4	SEE TABLE
13	9	869-9	SEE TABLE	13	9	869-9	SEE TABLE
14	4	841-571	SEE TABLE	14	4	841-571	SEE TABLE
15	1	928-39	SEE TABLE	15	1	928-39	SEE TABLE
16	1	950-414	SEE TABLE	16	1	950-414	SEE TABLE
17	1	817-481	SEE TABLE	17	1	817-481	SEE TABLE
18	1	817-399	SEE TABLE	18	1	817-399	SEE TABLE

- NOTES:**
- INSTALL PER ELECTRICAL SCHEMATIC.
  - ALL UNUSED FITTINGS MUST BE CAPED.
  - ITEM #1 FOR H.T.H.W. IS THE THERMOCOUPLE USED IN CONNECTION WITH THE LOCKWOOD CONTROLLER (817-4030), WHICH IS EITHER CALLED OUT ON 146-0-106 FOR CB/LE/CB/W/4M, OR SUPPLIED IN THE BURNER PANEL FOR CB/LE/CB/W/4M. SEE SPEC E20-SH101 FOR CONFIGURATION/JUMPER DETAILS.
  - LENGTH OF THERMOCOUPLE WIRE USED IS BASED ON BOILER DIAMETER. ACTUAL LENGTH MAY BE AFFECTED BY PANEL LOCATIONS.  
48" DIA. = 18 FT. 72"-78" DIA. = 20 FT.  
58"-67" DIA. = 18 FT. 86"-108" DIA. = 24 FT.
  - WELLS LISTED FOR H.T.H.W. MAY ONLY BE RATED FOR THE INDICATED TEMPERATURE RANGE AT 150PSI. ALWAYS VERIFY THAT THE CONTROLS HAVE THE PROPER TEMPERATURE RANGES FOR THE ACTUAL JOB APPLICATION REQUIREMENTS.
  - A TIME DELAY MUST BE ADDED TO THE BURNER ORDER FOR LPMC FOR CB 30-125# H.W.
  - REQUIRES 1/2" X 3/4" BUSHING.
  - NON-IHMK ONLY



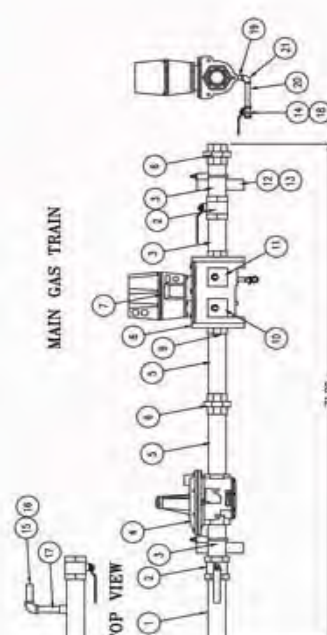
CB780/CB100/E100, H.T.H.W.



CB780/CB100/E100, 30-125#

## 8.2.15 — Gas Piping

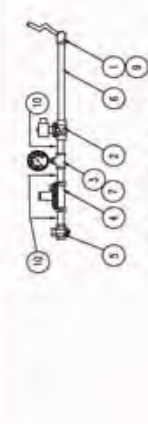
50-100 HP	
ITEM	QTY.
1	1
2	1
3	1
4	1
5	2
6	1
7	1
8	1
9	1
10	1
11	1
12	1
13	1
14	1
15	1
16	1
17	1
18	1
19	1
20	1
21	1



MAIN GAS TRAIN

50-100HP

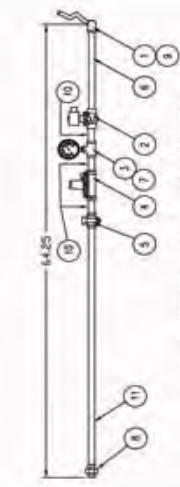
STARTER GAS TRAIN DIMENSIONS	
DIMENSION	CB BOILER DIA
A - DIST FROM FRONT OF BASERAIL	4B
B - HEIGHT FROM BOTTOM OF BASERAIL	5
C - AWAY FROM BASERAIL	10



101 & 600 FUEL SERIES

STARTER GAS TRAIN

STARTER GAS TRAIN

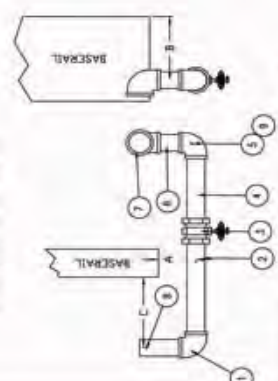


ALL EXCEPT 101 & 600 SERIES

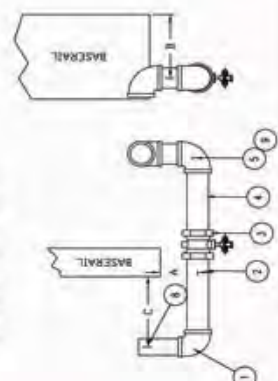
PILOT GAS TRAIN

50-100HP	
ITEM	QTY.
1	1
2	1
3	1
4	1
5	1
6	1
7	1
8	1
9	1
10	1
11	1

FOR CSO-1 W/ GAS PRESSURE GREATER THAN 3 PS SEE SHEET 3A



50-80 HP	
ITEM	QTY.
1	1
2	1
3	1
4	1
5	1
6	1
7	1

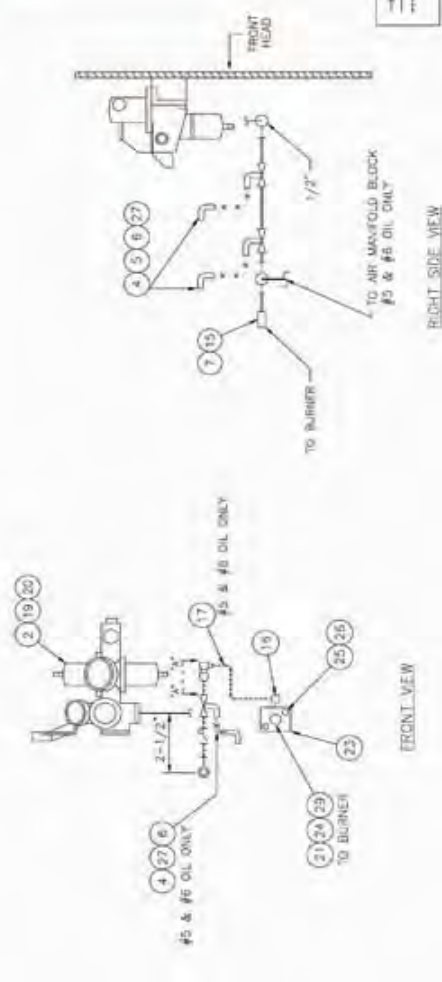
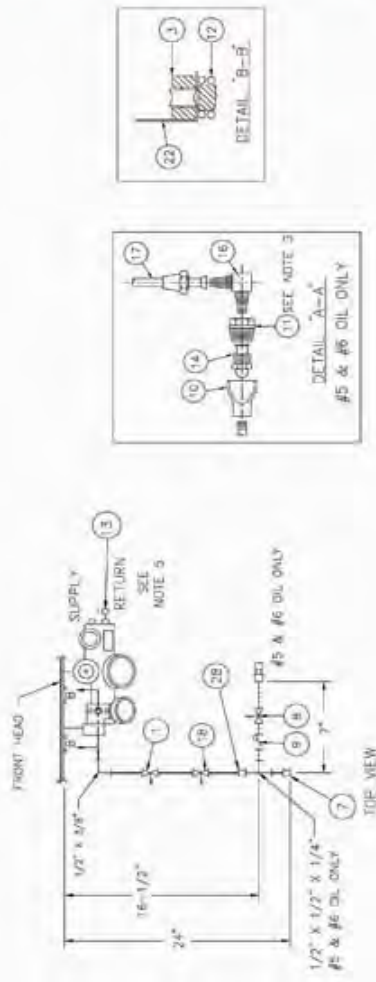


100 HP	
ITEM	QTY.
1	1
2	1
3	1
4	1
5	1
6	1
7	1
8	1



### 8.2.17 — H.O. Front Head Oil/Air Piping

ITEM	QUANTITY	PART NO.	DESCRIPTION	SOLE DR.	OPTION
1	1	846-154	VALVE, SOLIDWOOD, 3/8"	—	AA
2	1	739-0-79	VALVE ASSEMBLY	—	AA
3	1	34-63	VALVE STEM (24-8-81)	0300-80	AA
4	1	24-83	VALVE STEM (24-8-81)	03000	AA
5	1	24-84	VALVE STEM (24-8-81)	CB100A & 125A	AA
6	3	827-6	DRIVEN END - 3/8" (DUE TO FIT)	—	AA
7	2	846-16	CONNECTOR - 3/8" x 3/8"	FM, FBL & BR ONLY	AA
8	2	846-100	CONNECTOR - 3/8" x 3/8"	—	AA
9	1	847-106	CORPUS, RED - 3/8" x 1/4"	—	AA
10	1	948-153	SCREW VALVE - 1/4"	#5 & #6 OIL ONLY	AA
11	1	949-710	CHECK VALVE - 1/4"	#5 & #6 OIL ONLY	AA
12	1	157-75	REDUCER - 1/2" x 1/4"	#5 & #6 OIL ONLY	AA
13	1	104-A-10	DRIVE BLOCK	#5 & #6 OIL ONLY	AA
14	1	82-8-83	COMPRESSION SPRING	#5 & #6 OIL ONLY	AA
15	2	845-312	CONNECTOR - 1/2" O.D. x 1/2" I.D.	—	AA
16	1	851-78	PURGE NOZZLE	50-60 W.P. #5 & #6	AA
17	1	851-77	PURGE NOZZLE	70-125A W.P. OIL ONLY	AA
18	2	845-43	FLARE - 1/4" O.D. x 1/8" I.D.	—	AA
19	1	527-A-1058	PURGE LINE TUBING ASSEMBLY	#5 & #6 OIL ONLY	AA
20	1	948-154	VALVE, SOLIDWOOD, 3/8"	—	AA
21	4	922-93	LOCKWASHER, 3/8"	—	AA
22	4	852-98	CAPSCREW, HEX. HD. 3/8" x 3/4" L.	—	AA
23	1	851-438	FLARE, ROZL. METAL	—	AA
24	1	20-A-20	GM BODY GUIDE	—	AA
25	1	108-A-118	AIR MANFOLD BLOCK	—	AA
26	1	90A-73	BLK. PIPE 3/8" x 1 1/2" LG. 1/4" E.	—	AA
27	2	851-93	LOCKWASHER 1/4"	—	AA
28	2	858-387	CAPSCREW- HD. HD. 1/4" x 20 x 2-3/4" L.	—	AA
29	1	841-81	CONNECTOR, DUPLEX 3/8"	#5 & #6 OIL ONLY	AA
30	1	847-420	BUSHING, HD. 1/2" x 3/8"	—	AA
31	1	847-423	BUSHING, HD. 3/4" x 3/8"	—	AA
32	1	8-3427	BRACKET	SEE NOTE 8	AA

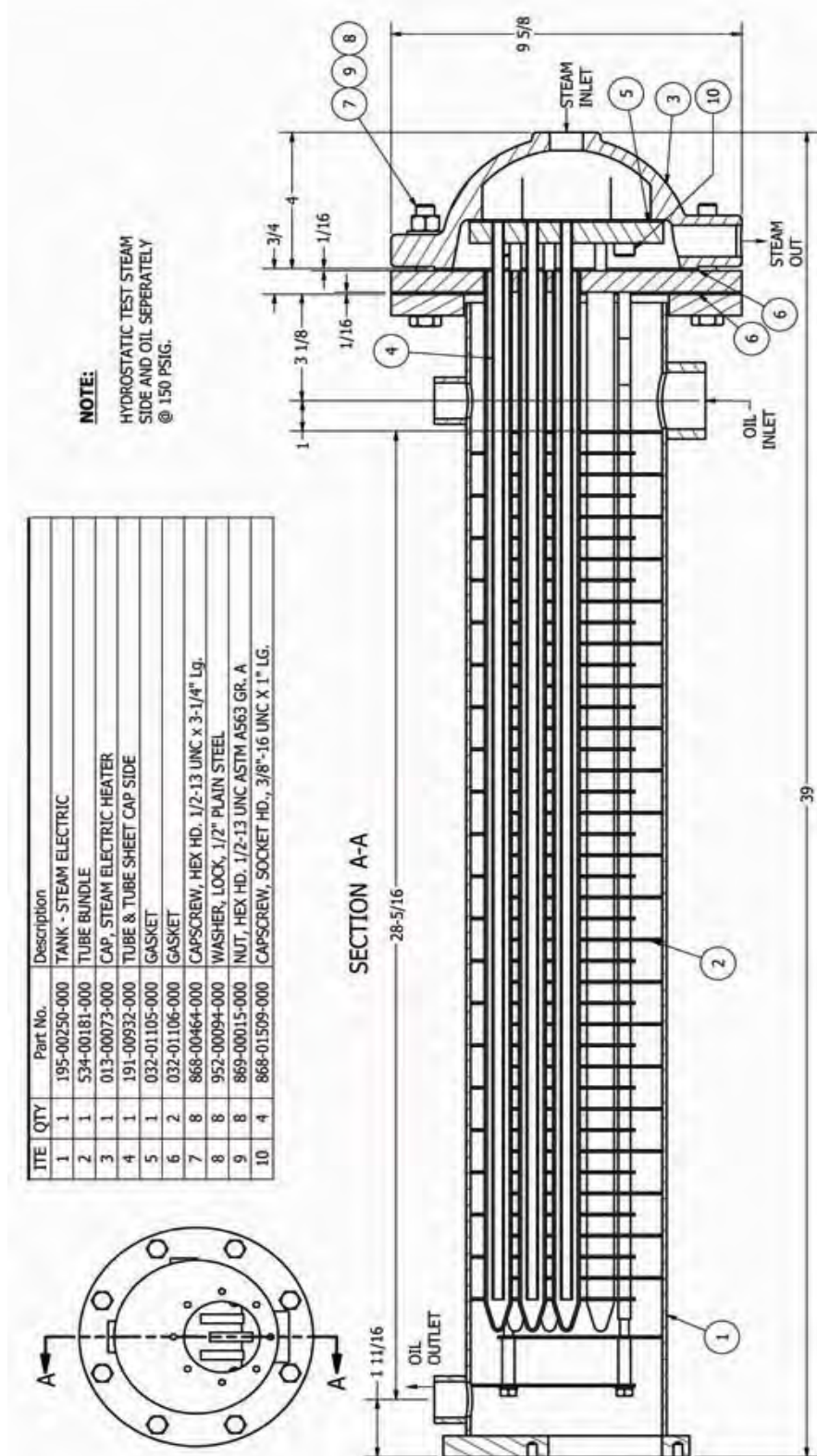


- NOTE:
- FOR AIR COMPRESSION PIPING REFER TO DIAG #148-D-163
  - UNLESS OTHERWISE NOTED, ALL OIL PIPE TO BE SCH. 40 ASTM A133 WELDED BLACK STEEL AND ALL FITTINGS TO BE 150# WELDED BLACK STEEL AND ALL PIPE TO BE 150# WELDED BLACK STEEL.
  - STAMP IN 2 ON EACH SIDE OF ITEM #11 FOR 50-60 W.P. ITEMS #11, 14, & 16 STAMPED AS 277-122.
  - 
  - FOR SUPPLY & RETURN PIPING REFER TO DIAG #148-D-143
  - ITEM #30 TO BE USED WITH SOLIDWOOD VALVES AND REPLACED BY AUTORIZED VALVES

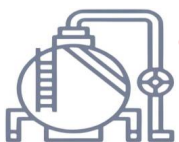




### 8.2.18 — Steam Electric Heater



Courtesy of: C3 Surplus LLC  
 Surplus Industrial Superstore  
 305-428-2777  
<https://www.c3surplus.com>



**Courtesy of: C3 Surplus LLC**  
**Surplus Industrial Superstore**  
**305-428-2777**  
**<https://www.c3surplus.com>**